

Model KXE

Operating Instructions

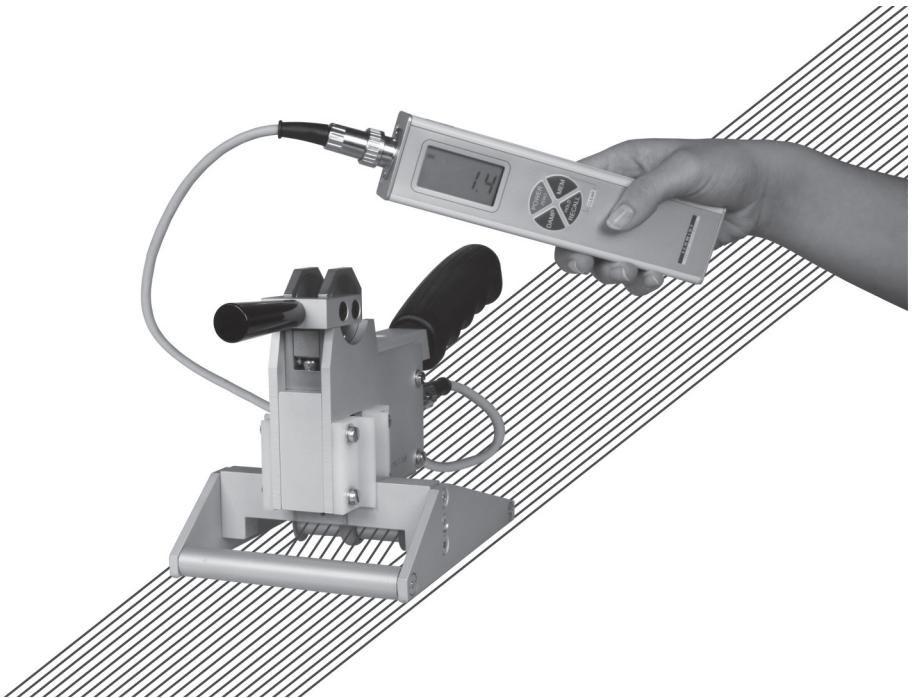

Contents

1 Warranty and Liability	3
1.1 Notices within the Operating Instructions.....	3
1.2 Responsibilities of the Operating Company	4
1.3 Responsibilities of the Personnel.....	4
1.4 Informal Safety Measures	4
1.5 Training of the Personnel.....	4
1.6 Intended Use.....	4
1.7 Dangers in Handling the Device.....	4
1.8 Copyright.....	5
1.9 Declaration of Conformity, RoHs II and WEEE Registration.....	5
2 Available Models.....	5
2.1 Specifications	5
2.2 Delivery Includes.....	6
2.3 Unpacking	6
3 Initial Setup and Operating Procedure	6
3.1 Notes Before Starting Measurement.....	7
3.1.1 ID Plate, CE Mark, Calibration Label.....	7
3.2 Operating Elements.....	7
3.3 Setup.....	8
3.3.1 Charging the Battery.....	8
3.3.2 Switch-On.....	8
3.3.3 Switch-Off.....	8
3.3.4 Reversing the Display.....	9
3.3.5 Zero Adjustment of the Measuring Position.....	9
3.4 Operating Procedure.....	10
3.4.1 Switching on Damping Mode.....	11
3.4.2 Changing the Damping Factor.....	11
3.5 Memory Modes	12
3.5.1 Memory Mode Selection.....	13
3.5.1.1 Data Logging in Mode “S” STANDARD	14
3.5.1.2 Data Logging in Mode “C” CONTINUOUS.....	14
3.5.1.3 Data Logging in Mode “L” LIMIT	15
3.5.1.4 Data Logging in Mode “F” FAST	16
3.5.2 Recalling the Stored Tension Values	17
3.5.2.1 Recalling the Stored Tension Values in Mode “S” STANDARD.....	17
3.5.2.2 Recalling the Stored Tension Values in Mode “C” CONTINUOUS	18
3.5.2.3 Recalling the Stored Tension Values in Mode “L” LIMIT.....	19
3.5.2.4 Recalling the Stored Tension Values in Mode “F” FAST	20
3.5.3 Clearing the KXE Memory.....	21
3.5.4 Memory Function HOLD.....	21
3.6 Error Messages.....	22
3.7 Static Verification of Measuring Accuracy.....	22
4 PC Communication (USB Interface).....	23
4.1 The TENSION INSPECT Program.....	23
4.2 WINDOWS Terminal Program	23

5 Service and Maintenance.....	23
5.1 Rollers.....	23
6 Cleaning.....	24
7 Correspondence.....	24
8 Repairs.....	24

1 Warranty and Liability

In principle, the supply of the device is subject to our “General Conditions of Sale and Delivery.” These have been provided to the operating company on conclusion of the contract, at the latest.

Warranty:

- SCHMIDT tension meters are warranted for 12 months.

Parts subject to wear, electronic components and measuring springs are not covered by the warranty. No warranty or liability will be accepted for bodily injury or property damage resulting from one or several of the following causes:

- Misuse or abuse of the device.
- Improper mounting, commissioning, operation and maintenance of the device (e.g. verification interval).
- Operation of the device if any safeguards are defective or if any safety and protection precautions are not properly installed or not operative.
- Failure to comply with the notices in the Operating Instructions regarding transport, storage, mounting, commissioning, operation, maintenance and setup of the device.
- Any unauthorized structural alteration of the device.
- Insufficient inspection of device components that are subject to wear.
- Opening the device or improper repair work.
- Disasters caused by the effects of foreign objects or by force majeure.

1.1 Notices within the Operating Instructions

The fundamental prerequisite for the safe handling of this device and its troublefree operation is the knowledge of the basic safety notices and safety instructions.

These Operating Instructions contain the most important notices for the safe operation of the device.

These Operating Instructions, in particular the safety notices, must be observed by any person who works with the device. In addition, the local applicable rules and regulations for the prevention of accidents must be complied with.

The representations within the Operating Instructions are not true to scale.

The dimensions given are not binding.

General indications of direction, such as FRONT, REAR, RIGHT, LEFT apply when viewing the front of the device.

1.2 Responsibilities of the Operating Company

In compliance with the EC Directive 89/655/EEC, the operating company agrees to only permit persons to work with the device who:

- are familiar with the basic regulations on industrial safety and accident prevention and who have been trained in handling the device.
- have read and understood the chapter on safety and the warning notices in these Operating Instructions and have confirmed this with their signatures.
- are examined regularly on their safe and conscientious working method.

1.3 Responsibilities of the Personnel

All persons who work with the device agree to perform the following duties before starting work:

- to observe the basic regulations on industrial safety and accident prevention.
- to read the chapter on safety and the warning notices in these Operating Instructions and to confirm with their signatures that they have understood them.

1.4 Informal Safety Measures

The Operating Instructions must always be kept on hand where the device is operated. Apart from the Operating Instructions, the general and local applicable regulations on accident prevention and environmental protection must be provided and complied with.

1.5 Training of the Personnel

Only trained and instructed personnel is permitted to work with the device. The responsibilities of the personnel must be clearly defined for mounting, commissioning, operation, setup, maintenance, and repair. Trainees may only work with the device under the supervision of experienced personnel.

1.6 Intended Use

The device is intended exclusively to be used as a tension meter. Any other use or any use exceeding this intention will be regarded as misuse. Under no circumstances shall HANS SCHMIDT & Co GmbH be held liable for damage resulting from misuse.

The intended use also includes:

- Complying with all notices included in the Operating Instructions and observing all inspection and maintenance works.

1.7 Dangers in Handling the Device

The device was designed according to the state of the art and the approved safety standards. Nevertheless, its use may cause serious or fatal injury to the user or third persons, and/or an impairment of the device or of other material assets.

The device may only be applied:

- For its intended use in a faultless condition with regard to the safety requirements.
- Malfunctions that could impair safety must be remedied immediately.
- Personal protective equipment must be used according to the EC Directive 89/686/EEC.



The device must not be operated in potentially explosive areas and must not come into contact with aggressive substances.

1.8 Copyright

The copyright on these Operating Instructions remains with the company HANS SCHMIDT & Co GmbH.

These Operating Instructions are intended for the operating company and its personnel only. They contain instructions and notices that may only be reproduced on the prior written permission of

HANS SCHMIDT & Co GmbH

and under indication of the complete reference data.

Violations will be prosecuted.

1.9 Declaration of Conformity, RoHs II and WEEE Registration

In compliance with the EU Directives 2004/108/EG and 2011/65/EU



HANS SCHMIDT & CO GmbH is registered in compliance with the German Electrical and Electronic Equipment Act (ElektroG) under WEEE Reg. No. DE 48092317.

2 Available Models

Model	Measuring Range daN	SCHMIDT Calibration
KXE-20	0.5 - 20.0	fabric tape
KXE-50	0.5 - 50.0	fabric tape

2.1 Specifications

Display Unit:

Calibration: According to SCHMIDT factory procedure

Units of Measure: daN

Accuracy: $\pm 1\% \text{ FS}^* \pm 1 \text{ digit}$ (typically $\pm 0.5\% \text{ FS}^*$)

Overrange: $10\% \text{ FS}^*$, without accuracy guarantee

Overload Protection: $200\% \text{ FS}^*$

Measuring Principle: Strain gauge bridge

Signal Processing: Digital 24 bit A/D converter

Damping: Adjustable electronically (averaging)

Measuring Frequency: Approx. 1 kHz internally

Display Update Rate: 2x per second

Display: 4-digit LCD, height of digit 11 mm

Memory: Average, last value, MAX, MIN, MAX_{PEAK}, MIN_{PEAK}

Memory Modes: 4 - for up to 4000 readings

Temperature Coefficient: Gain: less than $\pm 0.01\% \text{ FS}^*/^\circ\text{C}$

Analog Output Signal: 0 - 2 V DC (linearized) $R_{\text{Load}} > 1 \text{ k}\Omega \pm \text{approx. } 1\%$
(optional) Converter frequency 100 Hz

Digital Output Signal: USB

Temperature Range: 10 - 45 ° C

Air Humidity: 85% RH, max.

Auto Power Off: Automatically after approx. 3 min. of non-use

Power Supply: LiPo accumulator (approx. 60 h continuous use, charging time approx. 3.5 h) and AC adapter 100 - 240 V AC with 3 adapters (EU/USA/UK)

Housing Material: Aluminium profile with plastic outer casing (PVC)

Housing Dimensions: 197 mm x 58 mm x 47 mm (L x W x H)

Weight, net (gross): Approx. 340 g / 1250 g

*FS = Full Scale

2.1 Specifications (Cont.)

Sensor:

Measuring Rollers: 2x 22 mm ball bearing rollers

Width of Outer Rollers: 100 mm (ball bearing rollers)

Total Width of Rollers: 50 mm

Reference Frame Height Adjustment: 24 mm

Material: Anodized aluminium

Dimensions Reference Frame: 108 x 138 mm (L x W x H)

Weight, net (gross): 1000 g (1500 g)

2.2 Delivery Includes

Tension meter

1 EK0662: USB cable

1 K50202 AC adapter with 3 adapters (EU/USA/UK)

1 SW-TI3: "TENSION INSPECT 3" software (Win XP or higher) for viewing and storing the measured data on a PC.

1 Operating Instructions

1 Carrying case

2.3 Unpacking

Unpack the tension meter and inspect it for any shipping damage. Notices of defect must be filed immediately, in writing, at the latest within 10 days on receipt of the goods.

3 Initial Setup and Operating Procedure

General information

This mobile electronic tension meter has been developed according to the system of the INSTITUT TEXTILE DE FRANCE ITF. It allows measuring warp tensions of 50 mm wide warps while the machine is running or at standstill.

It is a well-known fact that accurate thread tension data can only be obtained when measuring a single end at a time using a stationary tension meter. The KXE model - System ITF - however allows setting machines of the same make and type to comparable averages. The use of the same settings for several weaving machines improves product quality and throughput, and saves energy.

You can insert the SENSOR into the warp and remove it again while the machine is running. The warp tension can be measured not only at the warp edges, but across the whole width without causing excessive deflection of the ends. Four different values can be displayed: Actual value, damped value, minimum value and maximum value. All readings can be stored in the KXE memory and evaluated on a PC. The KXE can be line- or battery-operated.

3.1 Notes Before Starting Measurement



Have you read and understood the Operating Instructions, in particular Chapter 1 “Basic Safety Notices” ?
You are not permitted to operate the tension meter before doing so.
Before working with the instrument you must put on your personal protective clothing, if necessary. For example, eye protectors, gloves, etc.
To avoid damage, do not move the center roller by hand.

Tensions that exceed the tension range of the instrument by more than 100% may cause permanent damage to the measuring spring and must be avoided under any circumstances.

3.1.1 ID Plate, CE Mark, Calibration Label



The ID plate with the CE mark and the serial number as well as the calibration label (optional) are provided on the bottom of the display unit, the SCHMIDT Quality Seal is provided on the surface.

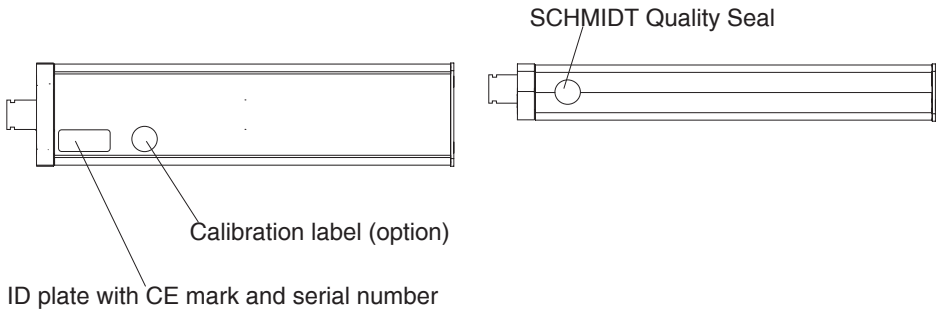

3.2 Operating Elements

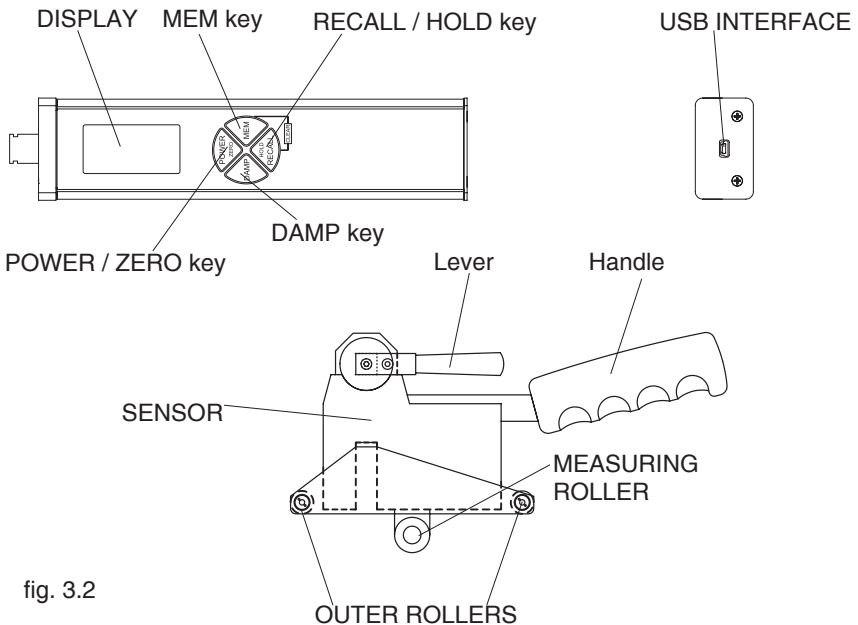



fig. 3.2

3.3 Setup

The tension meter comes with a built-in rechargeable LiPo battery, which has been charged at the factory. The tension meter can only be switched on if the battery is still working, i.e. if the battery has enough charge. If the instrument does not power up or if the battery level indicator shows only one bar  after power-up (Chapter 3.3.2), the battery needs to be recharged.



To ensure maximum battery life, avoid discharging it completely or charging it frequently for short periods. The battery should not be stored for a prolonged time when empty. After a maximum storage period of one year, the battery has to be recharged.

3.3.1 Charging the Battery



The battery can only be charged at a temperature between +5 °C and +45 °C. Before you connect the AC adapter, verify that the supply voltage is correct (100 V - 240 V).

HANS SCHMIDT & Co. GmbH provides no warranty or liability for any damage resulting from the use of AC adapters from other manufacturers.

To charge the battery, connect the cable of the AC adapter to the low USB output. The battery can also be charged by connecting the USB cable to a PC.

When the battery is fully charged, the battery level indicator will show 3 bars ,. The charging time is approx. 3 ½ hours.



Battery overcharging is not possible

3.3.2 Switch-On

Press the POWER key until all symbols are shown on the DISPLAY



When you release the key, the DISPLAY momentarily shows the tension range and the software version, e.g. E 1.0, followed by random values or "0."

3.3.3 Switch-Off

Auto power off:

- The tension meter switches off automatically after 3 minutes of non-use.

Manual switch-off:

- Press the POWER key for five seconds.

3.3.4 Reversing the Display

When you shift the tension meter from the right to the left hand, you can rotate the readings on the DISPLAY by 180°.

Measuring with the display unit in the left hand:

If you would like to use the left hand for measuring, you should reverse the readings on the DISPLAY to make them easier to read.

Requirement:

Tension meter switched off as described in Chapter 3.3.2.

To reverse the display:

- Press and hold the DAMP and POWER keys until the DISPLAY shows the readings the other way around.

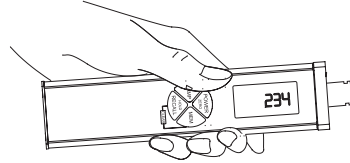

fig. 3.3.4a

Measuring with the display unit in the right hand:

Requirement:

Tension meter switched off as described in Chapter 3.3.2.

To restore the default orientation:

- Press and hold the DAMP and POWER keys until the DISPLAY shows the readings in the default orientation.

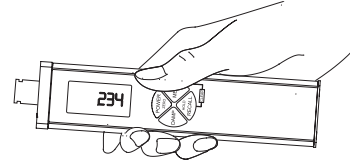

fig. 3.3.4b



The selected display orientation remains stored in the KXE memory even after the instrument is switched off.

3.3.5 Zero Adjustment of the Measuring Position



Before starting measurement you need to carry out zero adjustment, as described below, each time the tension meter is switched on. This procedure is necessary to compensate for the weight of the measuring roller in the measuring position. The zero adjustment for the new measuring path only remains effective until the instrument is switched off.

Zero adjustment must be repeated whenever the material path is changed or the tension meter does not display "0."

The process material must not yet be inserted!

Requirements:

- Tension meter switched on as described in Chapter 3.3.2.

To carry out zero adjustment:

- Holding the SENSOR at the HANDLE, place it in the desired measuring position. Be careful to hold the instrument absolutely steady.
- Press the POWER key.

The DISPLAY momentarily shows  and then switches to .
The KXE is now adjusted for the new material path and is ready to measure.

3.4 Operating Procedure

Requirements:

- Tension meter switched on (Ch. 3.3.2).
- Damping factor set, if necessary (Ch. 3.4.2).
- Zero adjustment carried out (Ch. 3.3.5).

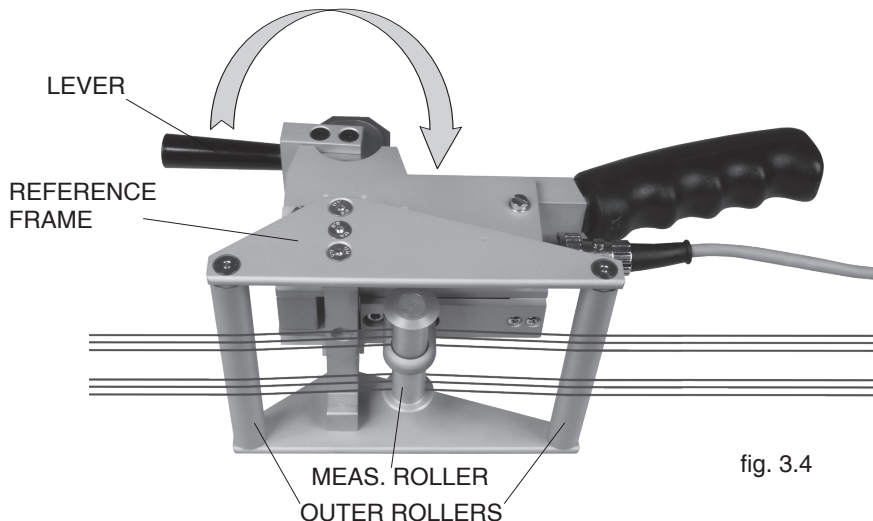

fig. 3.4

To insert the process material:

- Push the LEVER in the direction of the arrow to lift the REFERENCE FRAME and the OUTER ROLLERS.
- Insert the MEASURING ROLLER into the warp.
- Push the LEVER back into the original position to move the REFERENCE FRAME and the OUTER ROLLERS down again.

It is important to assure that the warp passes smoothly between the MEASURING ROLLERS and the OUTER ROLLERS.

To measure the process material:

The DISPLAY now shows the measured tension values.

Error messages which might be displayed are described in Chapter 3.6.

To remove the process material:

- Push the LEVER in the direction of the arrow to lift the REFERENCE FRAME and the OUTER ROLLERS.
- Remove the MEASURING ROLLER from the warp



After removing the process material, move the REFERENCE FRAME down by using the leve, to protect the MEASURING ROLLER of damage.

3.4.1 Switching on Damping Mode

The KXE is equipped with an electronic damping which ensures steady readings when tension fluctuates. This is achieved by averaging the measured values at the set update rate.



Before switching on the damping mode, it is recommended that you measure the first values without damping enabled.

Requirements:

- Process material inserted as described in Chapter 3.4.
- The DISPLAY has shown the first tension values.

To switch on damping:

- Press the DAMP key.
The DISPLAY shows the set damping factor.
- Release the DAMP key.

The DISPLAY shows  DAMP below the currently measured value.

To switch off damping:

- Press the DAMP key.

The DISPLAY shows  only the currently measured value.

3.4.2 Changing the Damping Factor

The tension meter is factory preset to a damping factor of 12. The tension values are thereby averaged for the display in the following way:

$$\frac{12 \text{ old values} + 4 \text{ new values}}{16}$$

The damping factor can be modified in 15 steps from 01 = low damping:

$$\frac{1 \text{ old value} + 15 \text{ new values}}{16}$$

to 15 = high damping:

$$\frac{15 \text{ old values} + 1 \text{ new value}}{16}$$

Requirement:

- Tension meter switched on as described in Chapter 3.3.2.

To change the damping factor:

- Press and hold the DAMP key.
The DISPLAY shows the set damping factor.
You can now increase the damping factor with the MEM key and decrease it with the RECALL key.
- Release the DAMP key.
The tension meter switches back to measuring mode.



The selected damping factor remains stored in the KXE memory even after the instrument is switched off.

3.5 Memory Modes

The tension meter features a data logger with a memory capacity for up to 4000 readings, with which you can store different measuring periods at one or more machine positions.

The readings are saved 2x per second, synchronously with the display update rate, in all memory modes except the “F” mode in which they are saved 100x per second. All saved readings and statistics can be shown on the display or transmitted to a PC (e.g. for further processing in Excel). The memory can be allocated to different measuring periods, depending on the memory mode.

Memory Mode	S	C	L	F
Meas. periods, max.	255	255	255	255
Readings, max.	-	4000	4000	4000
Max. no. of readings per position	-	Any	10	Any
Statistics	Yes	Yes	Yes	Yes
Save readings	-	Yes	Yes	Yes

Memory mode “S” STANDARD (default):

The following values of a measuring period are calculated and saved at a rate of 2 readings per second:

Average value,
 Last value,
 Maximum value (MAX),
 Minimum value (MIN),
 Minimum peak value (MIN PEAK)
 Maximum peak value (MAX PEAK)

Individual readings are not saved. You can save up to 255 measuring periods.

Memory mode “C” CONTINUOUS:

The following values of a measuring period are calculated and all readings are additionally saved at a rate of 2 readings per second:

Average value,
 Last value,
 Maximum value (MAX),
 Minimum value (MIN),
 Minimum peak value (MIN PEAK)
 Maximum peak value (MAX PEAK)

You can save up to 4000 readings, split up into up to 255 measuring periods.

Memory mode “L” LIMIT:

The following values of a measuring period are calculated and 10 readings are additionally saved at a rate of 2 readings per second:

Average value,
 Last value,
 Maximum value (MAX),
 Minimum value (MIN),
 Minimum peak value (MIN PEAK)
 Maximum peak value (MAX PEAK)

You can save up to 255 measuring periods with 10 readings each.

Memory mode “F” FAST:

The following values of a measuring period are calculated and all readings are additionally saved at a rate of 100 readings per second:

Average value,
 Last value,
 Maximum value (MAX),
 Minimum value (MIN),
 Minimum peak value (MIN PEAK)
 Maximum peak value (MAX PEAK)

You can save up to 4000 readings, split up into up to 255 measuring periods.

i The selected memory mode remains stored in the KXE memory even after the instrument is switched off.

3.5.1 Memory Mode Selection

Requirements:

- Tension meter switched on as described in Chapter 3.3.2.
- Memory cleared by simultaneously pressing the MEM and RECALL keys.

To select the memory mode:

- Press and hold the MEM key.

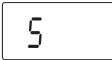
The DISPLAY shows  **S**.

Press the DAMP or RECALL key to change the memory mode.

Memory mode “S” STANDARD (default):

The DISPLAY shows  **S**.

The STANDARD memory mode is set.

Memory mode “C” CONTINUOUS:

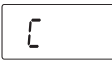
If the DISPLAY shows  **C**, the CONTINUOUS memory mode is set.

Memory mode “L” LIMIT:

If the DISPLAY shows  **L**, the LIMIT memory mode is set.

Memory mode “F” FAST:

If the DISPLAY shows  **F**, the FAST memory mode is set.

When you have selected the desired memory mode, you can release the MEM key. The selected memory mode is now active and the tension meter switches back to measuring mode.



The selected memory mode remains stored in the KXE memory even after the instrument is switched off.

3.5.1.1 Data Logging in Mode “S” STANDARD

Requirements:

- Tension meter switched on as described in Chapter 3.3.2.
- **Memory mode “S” STANDARD** set as described in Chapter 3.5.1.
- Process material inserted as described in Chapter 3.4.

To save the first measuring period:

- Press and hold the MEM key until the

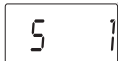

DISPLAY shows the memory mode “S” and the current memory number.

- Release the MEM key.

The tension meter starts logging the data.

While the tension data are stored, the MEM  indicator blinks on the DISPLAY and the currently measured value is displayed.

 **The logged tension values remain stored in the KXE memory even after the instrument is switched off.**

To stop data logging:

- When you want to end the measuring period, press the MEM key once again.

The statistical values are calculated from the logged tension data and stored in the following order:

- Average value,
- Last value,
- Maximum value (MAX),
- Minimum value (MIN),
- Minimum peak value (MIN PEAK),
- Maximum peak value (MAX PEAK).



The MEM  indicator stops blinking and remains on the display. The tension meter shows the current reading and changes back to measuring mode.

To save the next measuring period:

- Press the MEM key again.

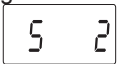
The DISPLAY shows  the memory mode “S” and the next memory number. You can save up to 255 measuring periods.

3.5.1.2 Data Logging in Mode “C” CONTINUOUS

Requirements:

- Tension meter switched on as described in Chapter 3.3.2.
- **Memory mode “C” CONTINUOUS** set as described in Chapter 3.5.1.
- Process material inserted as described in Chapter 3.4.

To save the first measuring period:

- Press and hold the MEM key until the

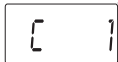

DISPLAY shows the memory mode “C” and the current memory number.

- Release the MEM key.

The tension meter starts logging the data.

While the tension data are stored, the MEM  indicator blinks on the DISPLAY and the currently measured value is displayed.

 **The logged tension values remain stored in the KXE memory even after the instrument is switched off.**

3.5.1.2 Data Logging in Mode “C” CONTINUOUS (Cont.)

To stop data logging:

- When you want to end the measuring period, press the MEM key once again. The statistical values are calculated from the logged tension data and stored in the following order:

Average value,	
Last value,	
Maximum value	(MAX),
Minimum value	(MIN),
Minimum peak value	(MIN PEAK),
Maximum peak value	(MAX PEAK).
Tension value	- 1 -
Tension value	- 2 -
↓	
Tension value	- N- (up to 4000 tension values in up to 255 measuring periods)



The logged tension values remain stored in the XKE memory even after the instrument is switched off.

The MEM  indicator stops blinking and remains on the display. The tension meter shows the current reading and changes back to measuring mode.

To save the next measuring period:

- Press the MEM key again.

The DISPLAY shows  the memory mode “C” and the next memory number. You can save up to 255 measuring periods with a total of 4000 readings max.

3.5.1.3 Data Logging in Mode “L” LIMIT

Requirements:

- Tension meter switched on as described in Chapter 3.3.2.
- **Memory mode “L” LIMIT** set as described in Chapter 3.5.1.
- Process material inserted as described in Chapter 3.4.

To save the first measuring period:

- Press and hold the MEM key until the



The logged tension values remain stored in the XKE memory even after the instrument is switched off.

DISPLAY shows  the memory mode “L” and the current memory number.

- Release the MEM key.

The tension meter starts logging the data.

While the tension data are stored, the MEM  indicator blinks on the DISPLAY and the currently measured value is displayed.

To stop data logging:

- When you want to end the measuring period, press the MEM key once again. The statistical values are calculated from the logged tension data and stored in the following order:

Average value,	
Last value,	
Maximum value	(MAX),
Minimum value	(MIN),

3.5.1.3 Data Logging in Mode “L” LIMIT (Cont.)

Minimum peak value (MIN PEAK),
Maximum peak value (MAX PEAK).
Tension value - 1 -
Tension value - 2 -
↓
Tension value - 10 - (up to 10 tension values in up to
255 measuring periods)

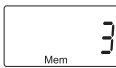
The MEM  indicator stops blinking and remains on the display. The tension meter shows the current reading and changes back to measuring mode.

To save the next measuring period:

- Press the MEM key again.

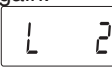
The DISPLAY shows  the memory mode “L” and the next memory number. You can save up to 255 measuring periods with up to 10 readings each.

3.5.1.4 Data Logging in Mode “F” FAST

Requirements:

- Tension meter switched on as described in Chapter 3.3.2.
- **Memory mode “F” FAST** set as described in Chapter 3.5.1.
- Process material inserted as described in Chapter 3.4.

To save the first measuring period:

- Press and hold the MEM key until the

 **The logged tension values remain stored in the KXE memory even after the instrument is switched off.**

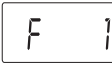
DISPLAY shows  the memory mode “F” and the current memory number.

- Release the MEM key.

The tension meter starts logging the data at a rate of 100 readings per second.

While the tension data are stored, the MEM  indicator blinks on the DISPLAY and the currently measured value is displayed.

To stop data logging:

- When you want to end the measuring period, press the MEM key once again. The statistical values are calculated from the logged tension data and stored in the following order:

Average value,
Last value,
Maximum value (MAX),
Minimum value (MIN),
Minimum peak value (MIN PEAK),
Maximum peak value (MAX PEAK).
Tension value - 1 -
Tension value - 2 -
↓
Tension value - N- (up to 4000 tension values in up to
255 measuring periods)

3.5.1.4 Data Logging in Mode “F” FAST (Cont.)

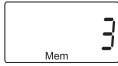

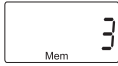
The MEM  indicator stops blinking and remains on the display. The tension meter shows the current reading and changes back to measuring mode.

To save the next measuring period:

- Press the MEM key again.

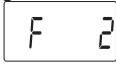

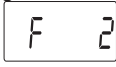
The DISPLAY shows  the memory mode “F” and the next memory number. You can save up to 255 measuring periods with a total of 4000 readings max.

3.5.2 Recalling the Stored Tension Values

With the TENSION INSPECT software from SCHMIDT, which is included with your tension meter, you can easily and accurately evaluate the stored tension values and export them to an Excel sheet.

3.5.2.1 Recalling the Stored Tension Values in Mode “S” STANDARD Requirement:



- Tension meter switched on as described in Chapter 3.3.2.

To recall the tension values:

- Press the RECALL key.

You can end recall any time by pressing the POWER key.

Memory Mode STANDARD →							
↓ Pos:	1	Pos:	2	Pos:	3	Pos:	4
AVG:	22.0	AVG:	12.0	AVG:	12.0	AVG:	12.0
▲ Last:	23.0	Last:	22.1	Last:	22.1	Last:	22.1
▼ MAX:	24.0	MAX:	22.1	MAX:	22.1	MAX:	22.1
▲ _{Peak} MIN:	21.0	MIN:	5.4	MIN:	5.4	MIN:	5.4
▼ _{Peak} PEAK _{MAX} :	26.0	PEAK _{MAX} :	28.1	PEAK _{MAX} :	28.1	PEAK _{MAX} :	28.1
PEAK _{MIN} :	19.0	PEAK _{MIN} :	1.8	PEAK _{MIN} :	1.8	PEAK _{MIN} :	1.8

The DISPLAY blinks, showing  the **average value** (AVG) of the first measuring period (POS: 1) and the  symbol.

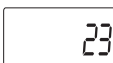
- Press the RECALL key. The DISPLAY blinks, showing  the **last value** (LAST) of the measuring period.

- Press the RECALL key. The DISPLAY blinks, showing  the **maximum value** (MAX) of the measuring period and the ▲ symbol.

- Press the RECALL key. The DISPLAY blinks, showing  the **minimum value** (MIN) of the measuring period and the ▼ symbol.

- Press the RECALL key. The DISPLAY blinks, showing  the **maximum peak value** (PEAK_{MAX}) of the measuring period, the PEAK indicator

3.5.2.1 Recalling the Stored Tension Values in Mode “S” STANDARD (Cont.)

and the ▲ symbol.

- Press the RECALL key. The DISPLAY blinks, showing  the **minimum peak value** (PEAK_{MIN}) of the measuring period, the PEAK indicator and the ▼ symbol.

- Press the RECALL key.

The next measuring period (POS: 2) is shown on the DISPLAY, starting with the **average value** (AVG).

3.5.2.2 Recalling the Stored Tension Values in Mode “C” CONTINUOUS

Requirement:

- Tension meter switched on as described in Chapter 3.3.2.

To recall the tension values:

- Press the RECALL key.

You can end recall any time by pressing the POWER key.

Memory Mode CONTINUOUS → → → → → → → → → → → → → → → →							
Pos:	1	Pos:	2	Pos:	3	Pos:	4
▼ AVG:	22.0	AVG:	12.0	AVG:	12.0	AVG:	12.0
Last:	23.0	Last:	22.1	Last:	22.1	Last:	22.1
▲ MAX:	24.0	MAX:	22.1	MAX:	22.1	MAX:	22.1
▼ MIN:	21.0	MIN:	5.4	MIN:	5.4	MIN:	5.4
▲ _{Peak} PEAK _{MAX} *	26.0	PEAK _{MAX} *	28.1	PEAK _{MAX} *	28.1	PEAK _{MAX} *	28.1
▼ _{Peak} PEAK _{MIN} *	19.0	PEAK _{MIN} *	1.8	PEAK _{MIN} *	1.8	PEAK _{MIN} *	1.8
	10.8		14.2		14.1		15.4
	10.0		19.4		11.2		18.3
	7.3		22.9		8.9		17.5
	6.1		17.3		10.2		7.8
	↓		↓		↓		↓
	n		n		n		n

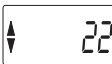

The DISPLAY blinks, showing  the **average value** (AVG) of the first measuring period (POS: 1) and the ▼ symbol.

- Press the RECALL key. The DISPLAY blinks, showing  the **last value** (LAST) of the measuring period.

- Press the RECALL key. The DISPLAY blinks, showing  the **maximum value** (MAX) of the measuring period and the ▲ symbol.

- Press the RECALL key. The DISPLAY blinks, showing  the **minimum value** (MIN) of the measuring period and the ▼ symbol.

3.5.2.2 Recalling the Stored Tension Values in Mode “C“ CONTINUOUS (Cont.)

- Press the RECALL key. The DISPLAY blinks, showing  the **maximum peak value** (PEAK_{MAX}) of the measuring period, the PEAK indicator and the ▲ symbol.
- Press the RECALL key. The DISPLAY blinks, showing  the **minimum peak value** (PEAK_{MIN}) of the measuring period, the PEAK indicator and the ▼ symbol.
- Press the RECALL key. The measured values no. 1 — n of the first measuring period can be recalled.
- Press the RECALL key.
The next measuring period (POS: 2) is shown on the DISPLAY, starting with the **average value** (AVG).

3.5.2.3 Recalling the Stored Tension Values in Mode “L“ LIMIT Requirement:

- Tension meter switched on as described in Chapter 3.3.2.

To recall the tension values:

- Press the RECALL key.

You can end recall any time by pressing the POWER key.

Memory Mode LIMIT ⇒							
Pos:	1	Pos:	2	Pos:	3	Pos:	4
↕ AVG:	22.0	AVG:	12.0	AVG:	12.0	AVG:	12.0
Last:	23.0	Last:	22.1	Last:	22.1	Last:	22.1
▲ MAX:	24.0	MAX:	22.1	MAX:	22.1	MAX:	22.1
▼ MIN:	21.0	MIN:	5.4	MIN:	5.4	MIN:	5.4
▲ _{Peak} PEAK _{MAX} :	26.0	PEAK _{MAX} :	28.1	PEAK _{MAX} :	28.1	PEAK _{MAX} :	28.1
▼ _{Peak} PEAK _{MIN} :	19.0	PEAK _{MIN} :	1.8	PEAK _{MIN} :	1.8	PEAK _{MIN} :	1.8
	10.8		14.2		14.1		15.4
	10.0		19.4		11.2		18.3
	7.3		22.9		8.9		17.5
	6.1		17.3		10.2		7.8
	↓		↓		↓		↓
	n		10		10		10

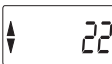
The DISPLAY blinks, showing  the **average value** (AVG) of the first measuring period (POS: 1) and the ↕ symbol.

- Press the RECALL key. The DISPLAY blinks, showing  the **last value** (LAST) of the measuring period.

- Press the RECALL key. The DISPLAY blinks, showing  the

3.5.2.3 Recalling the Stored Tension Values in Mode “L” LIMIT (Cont.)

maximum value (MAX) of the measuring period and the ▲ symbol.

- Press the RECALL key. The DISPLAY blinks, showing  the **minimum value** (MIN) of the measuring period and the ▼ symbol.

- Press the RECALL key. The DISPLAY blinks, showing  the **maximum peak value** (PEAK_{MAX}) of the measuring period, the PEAK indicator and the ▲ symbol.

- Press the RECALL key. The DISPLAY blinks, showing  the **minimum peak value** (PEAK_{MIN}) of the measuring period, the PEAK indicator and the ▼ symbol.

- Press the RECALL key. The measured values no. 1 — 10 of the first measuring period can be recalled.

- Press the RECALL key.

The next measuring period (POS: 2) is shown on the DISPLAY, starting with the **average value** (AVG).

3.5.2.4 Recalling the Stored Tension Values in Mode “F” FAST

Requirement:

- Tension meter switched on as described in Chapter 3.3.2.

To recall the tension values:

- Press the RECALL key.

You can end recall any time by pressing the POWER key.

Memory Mode FAST →							
Pos:	1	Pos:	2	Pos:	3	Pos:	4
▼ AVG:	22.0	AVG:	12.0	AVG:	12.0	AVG:	12.0
Last:	23.0	Last:	22.1	Last:	22.1	Last:	22.1
▲ MAX:	24.0	MAX:	22.1	MAX:	22.1	MAX:	22.1
▼ MIN:	21.0	MIN:	5.4	MIN:	5.4	MIN:	5.4
▲ _{Peak} PEAK _{MAX} :	26.0	PEAK _{MAX} :	28.1	PEAK _{MAX} :	28.1	PEAK _{MAX} :	28.1
▼ _{Peak} PEAK _{MIN} :	19.0	PEAK _{MIN} :	1.8	PEAK _{MIN} :	1.8	PEAK _{MIN} :	1.8
	10.8		14.2		14.1		15.4
	10.0		19.4		11.2		18.3
	7.3		22.9		8.9		17.5
	6.1		17.3		10.2		7.8
	↓		↓		↓		↓
	n		n		n		n

The DISPLAY blinks, showing  the **average value** (AVG) of the first

3.5.2.4 Recalling the Stored Tension Values in Mode “F” FAST (Cont.)

measuring period (POS: 1) and the \updownarrow symbol.

- Press the RECALL key. The DISPLAY blinks, showing  the **last value** (LAST) of the measuring period.

- Press the RECALL key. The DISPLAY blinks, showing  the **maximum value** (MAX) of the measuring period and the \uparrow symbol.

- Press the RECALL key. The DISPLAY blinks, showing  the **minimum value** (MIN) of the measuring period and the \downarrow symbol.

- Press the RECALL key. The DISPLAY blinks, showing  the **maximum peak value** (PEAK_{MAX}) of the measuring period, the PEAK indicator and the \uparrow symbol.

- Press the RECALL key. The DISPLAY blinks, showing  the **minimum peak value** (PEAK_{MIN}) of the measuring period, the PEAK indicator and the \downarrow symbol.

- Press the RECALL key. The measured values no. 1 — n of the first measuring period can be recalled.

- Press the RECALL key.

The next measuring period (POS: 2) is shown on the DISPLAY, starting with the **average value** (AVG).

3.5.3 Clearing the KXE Memory

If values are stored in the KXE memory, the DISPLAY shows e.g.

 with the MEM indicator.

To clear the memory:

- Simultaneously press the MEM and RECALL keys.

The DISPLAY shows e.g. ; all values stored in the memory have been deleted.

3.5.4 Memory Function HOLD

When the tension meter memory is empty, you can retain the last reading on the DISPLAY by using the memory function HOLD.

To retain the last reading:

- Press the RECALL / HOLD key once for about 1 second.

The DISPLAY shows the last reading  and the “:” colon symbol.

To switch back to measuring mode:

- Press the RECALL / HOLD key once for about 1 second.

The tension meter switches back to measuring mode.

3.6 Error Messages



- The DISPLAY shows EEE. The upper limit of the tension range was exceeded by more than 10%. Reduce the line tension.

OR

AUTO ZERO is no longer possible. The instrument must be Recalibrate.



- The DISPLAY shows -E.E. The lower limit of the tension range was fallen below by more than 10%. Properly insert the process material.

OR

AUTO ZERO is no longer possible. The instrument must be Recalibrate.

3.7 Static Verification of Measuring Accuracy

All tension meters model KXE are calibrated with V-inweaved fabric tape (0.22 mm thick). The diameters are given in Chapter 2. Any difference in process material size and rigidity from the standard material may cause a deviation of the accuracy.

In 95% of all industrial applications, the SCHMIDT calibration has been proven to provide the best results and is used for comparative purposes.

Requirements:

- The ETX is factory calibrated for a horizontal material path (fig. 3.7).
- Tension meter switched on as described in Chapter 3.3.2.
- The required reference weight must be provided.

Verification procedure:

- Interlace the ends of the tape
- Hang a weight which corresponds to the tension to be measured above a DEFLEXION ROLLER from the measured material, vertically, as shown in fig. 3.7a.
- Thread the process material as described in Chapter 3.4. One part of the tape must run on the left and one on the right side of the measuring roller.
- The tension value shown on the DISPLAY should be equal to the value of the suspended weight (pay attention to the measuring units).

If this procedure shows a deviation, the instrument must be recalibrated by the manufacturer. Therefore the instrument can be calibrated using customer supplied samples.

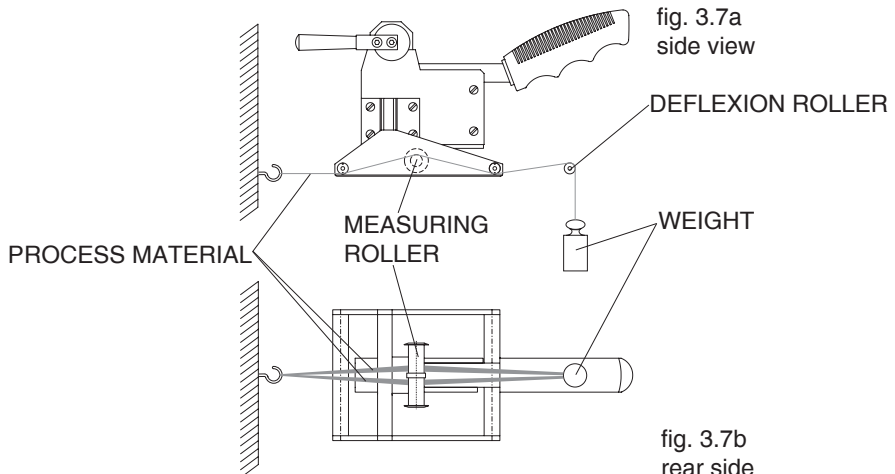

4 PC Communication (USB Interface)



The requirements of the CE specification are only complied with if the tension sensor is equipped and operated with display units and connecting cables supplied by HANS SCHMIDT & Co GmbH. Certification to the CE specification does not extend to, and shall be invalid for any other combination. Under no circumstances shall HANS SCHMIDT & Co GmbH be held liable for any damage resulting from the use of non-SCHMIDT sensors or cables.

4.1 The TENSION INSPECT 3 Program

The Tension Inspect software from SCHMIDT is described in a separate user manual.

4.2 WINDOWS Terminal Program

The measured values and the memory contents can be transmitted over the USB interface to a personal computer.

You can connect the computer to the INTERFACE of the KXE by using the EK-0662 special cable which is available as an accessory.

Requirements:

A communication program, such as Terminal or HyperTerminal (provided on MS Windows Version 3.0 or later), must be installed and configured on the computer.

Commands for communication with a PC (polling)

ASCII Code	Function	Description
s	Send	Transmission of the undamped reading.
d	Send	Transmit current reading to PC once.
r	Output	Output the memory contents to the PC.

5 Service and Maintenance

The tension meter is easy to maintain. Depending on operating time and load, the tension meter should be checked according to the locally applicable regulations and conditions (as described in Chapter 3.7). The use of other test methods than the procedure described in Chapter 3.7 may cause deviating measuring results.

5.1 Rollers

You should regularly inspect the rollers to assure that they are running easily and smoothly. The **rollers** can only be changed by the manufacturer.

6 Cleaning

For cleaning the unit, do not use any



AGGRESSIVE SOLVENTS

such as trichloroethylene or similar chemicals.



NO WARRANTY OR LIABILITY

shall be accepted for damage resulting from improper cleaning.

7 Correspondence

Should you have any questions regarding the instrument or Operating Instructions, or their use, please indicate above all the following details which are given on the ID plate:

- 1) Model
- 2) Serial number

8 Repairs

Shipping instructions:

We kindly ask for return free of charge for us, if possible by airmail parcel. All occurring charges, if any (such as freight, customs clearance, duty etc.), will be billed to customer. For return from foreign countries, we ask you to include a proforma invoice with a low value for customs clearance only, e.g. 50 Euro, each and to advise the shipment in advance by fax or eMail.

To avoid unnecessary follow-up questions, and the resulting loss of time or possible misunderstandings, please return the instrument with a detailed fault description to our service department. Please indicate in your order whether you require an Inspection Certificate 3.1 according to DIN EN 10204.