

## Operation Manual



**Warning**

Operators should wear protection such as a mask and gloves in case pieces or components break away from the unit under test.

Whether the unit is ON or OFF, DO NOT exceed the capacity of the gauge. NEVER exceed 150% of the rated capacity, or the load cell will be damaged. At 110% of the rated capacity, the display will flash a warning.

When mounting FG-3000 Series Digital Force Gauges, use M4 mounting screws with a maximum insertion depth of 7 mm into the gauge. Hand tighten mounting screws, DO NOT use tools. Do not use damaged clamp.

Measure in line tension and compression forces only. DO NOT attempt to measure forces at an angle to the measuring shaft – damage to load cell and/or shaft may result.

Do not attempt to repair or alter this instrument. Warranty will be voided and damage to the unit may result.

Use and store within the stated temperature and humidity ranges, or damage and failure may result.

When using adapter measuring heads, do not use tools. Hand tighten only.

The new FG-3000R Series digital force gauges are the choice for simple, cost-effective compression testing. Combining one of the most compact housings, yet maintaining a large back-lit LCD, these units were designed to fit perfectly in the hand for ease of use. The multi-language FG-3000's provide menu programming for intuitive set-up of the instrument to your desired requirements. Three modes of operation are selectable: Track mode displays live readings, Peak mode records the maximum reading sensed during the test, and Pre-set mode which activates user defined high and low limit set points. The programmable limits provide a quick visual and audible indication if a test passes or fails. In addition, a comparator output enables integration of the instrument into your quality system for repetitive testing such as on production lines.

The integral button style load-cell attached via the flexible, metal braided cable enables reading to be taken in machinery or fixtures where other force gauge adapters are unable to reach or fit.

The display graphics facilitate user comprehension and operation. An analog bar graph provides perspective of current reading in comparison to the full scale range. Pass/Fail icons provide an instant response of the testing outcome while a storage symbol acknowledges when a reading is logged. A menu-selectable display orientation streamlines switching from push to pull testing for portable or test stand applications.



### SPECIFICATIONS

**Accuracy:** ± 0.5% F.S.

**Selectable Units:** kN, kgf, N, klbf and lbf. (Depending on Range)

**Overload Capacity:** 150% of F.S. (LCD flashes beyond 110% of F.S.)

**Measurement Method:** Peak, Track, Preset

**Data Sampling Rate:** 1000 Hz

**Display:** 160\*128 dot matrix LCD with Backlight

**Display Update Rate:** 10 times/second

**Resolution:** (See chart)

**Memory:** 500 data

**Set Point:** Programmable high and low limits in Preset Mode

**Battery Indicator:** Display flashes battery icon when battery is low

**Power:** 3.6 VDC 400 mA Ni-MH rechargeable batteries

**Battery Life:** Approximately 16 hours continuous use per full charge

**Charger / Adaptor:** Universal USB/BM charger, Input: 110 ~ 240VAC

**Temperature Effects:** <0.054% per °F (0.03% FS per °C)

**Outputs:** USB, RS-232; High & Low Limit NPN's

**Operating Temperature:** 14 to 104°F (-10 to 40°C)

**Storage Relative Humidity:** 20 to 80%

**Housing:** Aluminum

**Storage Temperature:** -4 to 122°F (-20 to 50°C)

**Oper. Relative Humidity:** 5 to 95%

**Dimensions:** 5.5 x 2.8 x 1.4" (140 x 71 x 35.5 mm)

**Product Weight:** 1.1 lb (0.5 kg)

**Package Weight:** 2.8 lb (1.3 kg)

**Warranty:** 1 year

**Certification:** CE

**Included Accessories:** AC Adaptor/Charger, USB cable, calibration cert., carrying case

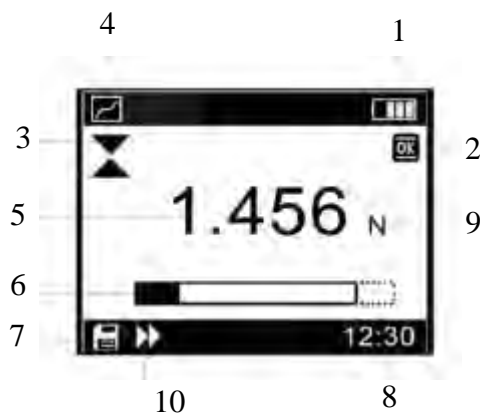

### LCD Screen

1. Battery icon: Battery level or charging status. Flashes when gauge needs to be recharged.
2. OK/OV Indicator: Measured value between low limit and upper limit; Value over upper limit  
 Value between lower limit and 75% of lower limit
3. Force icon: Indicates force direction. Tension  
 Compression
4. Test mode icon: Three measurement modes: Track, Peak and Preset
5. Current measured value
6. Analog bar: Indicates current position within full scale. When the bar enters the area enclosed by the dotted line, it means full scale capacity is exceeded and overload.
7. Storage icon: Indicates data is being saved.
8. System time
9. Units Indicator: Selected engineering unit.
10. Data Transmission icon

# 1. OPERATION

## 1.1 Key Functions

All keys are capacitive touch.



ON/OFF: Push for 1 second to power On or Off



During Measurement: Store data.  
In Menus: Back or quit.



During Measurement: Enter the menus.  
In Menus: Select or Enter



During Measurement: Track mode, tares weight of attachment. In Peak modes, resets the peak value.  
In Menus: Moves selection up or increases the value.



During Measurement: Changes the measure mode from Track, Peak or Preset  
In Menus: Moves selection down or decreases the value.

## 1.2 Modes

**Track:** Real time, live measuring mode.

**Peak:** Peak readings will not change until a higher value is measured.

**Preset:** User-defined set points GO/NG testing with available and visual indicators.

## 1.3 Menu Structure

The FG-3000R Series Force Gauge has multi-level menu interface (Table 1-3) that enables simple navigation and programming.

MENUS	SUBMENUS	SELECTIONS
Measurement	Unit	kN, N, kgf, lbf, klbf
	Test Mode	Track, Peak, Preset
Memory	Browse	
	Print	Selected, All
	Delete All	Yes, No
System	Display	Obverse, Reverse
	Auto Power	On, Off
	Backlight	On, Off
	Key Sound	On, Off
	Date/Time	
	Calibration	Yes, No
	Default	Yes, No
Language	English, Chinese, German	
Information	Range, SN, Version	

Table 1-3

# 2. PREPARATION

## 2.1 Confirm the model

This series force gauge has 5 ranges available, each model corresponding to the capacity and resolution shown on the last page of this manual. Select the appropriate model you need before use.

## 3. SETUP

### 3.1 Measurement

The Measurement menu contains the Unit of measure and Measurement Mode sub-menus, as shown in Fig. 3-1.

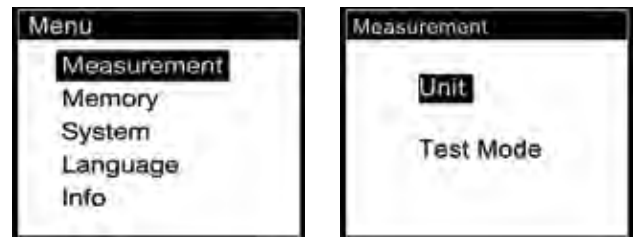

Fig. 3-1

### 3.2 Select Units

The measuring units can be selected under this menu. Different range models may have different unit selection capabilities. Touch "ZERO" or "MODE" keys to shift to the next selection. Press "LOG" to cancel or touch "MENU" to confirm and exit. (Fig. 3-2)

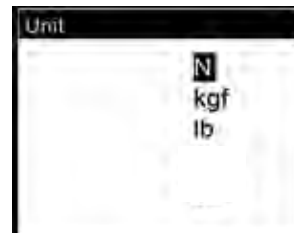

Fig. 3-2

### 3.3 Select Test Mode

The FG-3000R has 3 types of Test Modes.

**Track:** The real time measuring mode. Under this mode, press the ZERO key to tare any initial reading being displayed.

**Peak:** In Peak mode, the maximum force will be recorded and displayed. Press the ZERO key to reset the peak value.

**Preset:** Enables the setting of an upper and lower limit to compare to the measured force value. A simple GO/NG analysis is displayed on screen via icon indicators for quick pass/fail testing. To guarantee an accurate test, make sure to zero the display and tare any small force being displayed before beginning the test.

There are two means to select your appropriate Test Mode. At the home screen simply press the MODE key to scroll through the three measuring modes.

You can also select the mode under the Measurement menu in the Test Mode sub-menu. See Fig. 3-3(a)

If the Preset is selected, a new screen will pop up where you can set the Upper and Lower limits. See Fig 3-3(b)

Press ZERO to adjust the number and press MODE to move to the next digit.

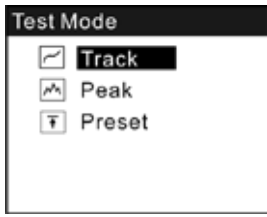

Fig. 3-3(a)

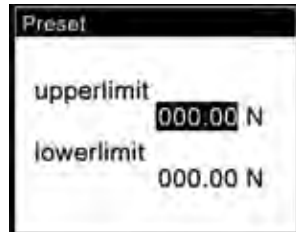

Fig. 3-3(b)

Note:

- 1) The upper limit can not exceed 110% capacity of the force gauge.
- 2) The lower limit must not be less than 10% of capacity.
- 3) The upper limit must exceed the lower limit

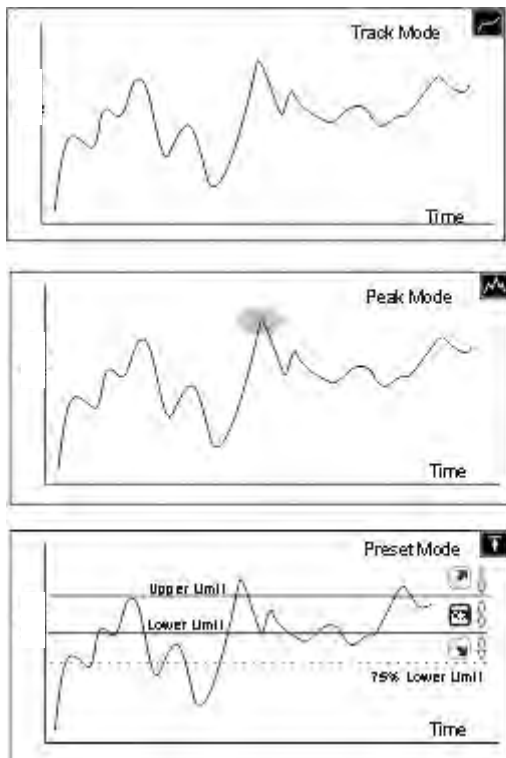

Fig. 3-4

#### 4. SAVING THE MEASURED VALUE

Measured results can be stored in the force gauge's memory. You can review or print the stored data at a later time.

At the home screen press the LOG key to store a value. The storage icon will be displayed.

The data stored is the current displayed force value in Track and Preset modes. In Peak mode it is the peak value shown on the display.

#### 4.1 Memory

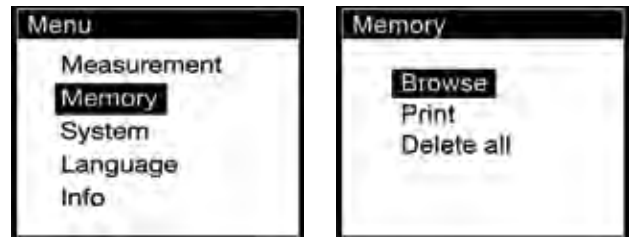

Fig. 4-1

Memory menu contains three submenus: Browse, Print, Delete all, as shown in Fig. 4-1.

You can browse stored data or print all the data via the FG-PRINTER mini-printer (sold separately). You may also delete all the records in the Delete all sub-menu.

#### 4.2 Browse

In the Browse sub-menu. The data in memory can be reviewed in the order saved which is oldest to newest. See Fig. 4-2(a)

Press ZERO/UP or MODE/DOWN to scroll.

Press MENU. A small window will pop out. Here you can select Delete or Print. See Fig. 4-2(b).

If you select Delete, a confirm window will appear asking you to confirm. Press MENU to confirm or LOG to exit.

No.	Force	Dir
007	1.4 kN	↔↔
008	2.58 kN	↔↔
009	37 kgf	↔↔
010	45 lbf	↔↔

Fig. 4-2(a)

No.	Force	Dir
007	1.4 kN	↔↔
008	25.8 N	↔↔
009	37 kg	↔↔
010	45 lbf	↔↔

Fig. 4-2(b)

#### 4.3 Print

You can print the data in memory. Enter Print. (Fig. 4-3) Choose Selected or All.

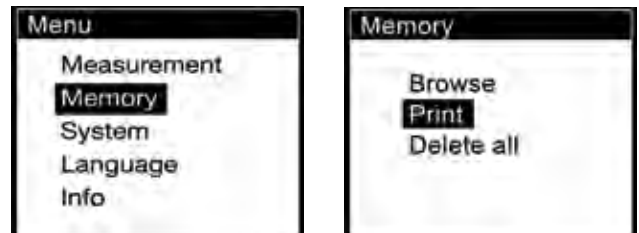

Fig. 4-3

If Selected is chosen, the total Range of available data points will be indicated. Adjust the value points to be printed to the right of Select. Fig. 4-3(a)

If All is selected, a confirm window will appear asking you to confirm. See Fig. 4-3(b).

Fig. 4-3(a)

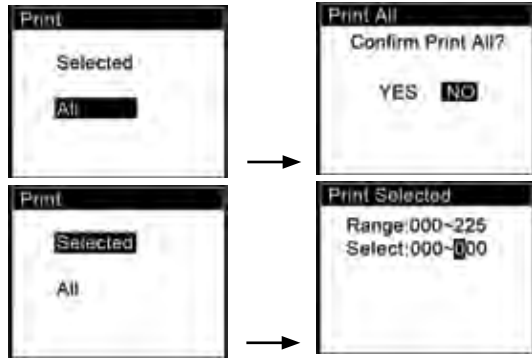

Fig. 4-3(b)



Fig. 5-1(a)



Fig. 5-1(b)

#### 4.4 Delete All

All data points can be cleared from memory under the Delete all sub-menu (Fig. 4-4). A confirm window will appear asking you to confirm. See Browse for details on deleting individual points one at a time.

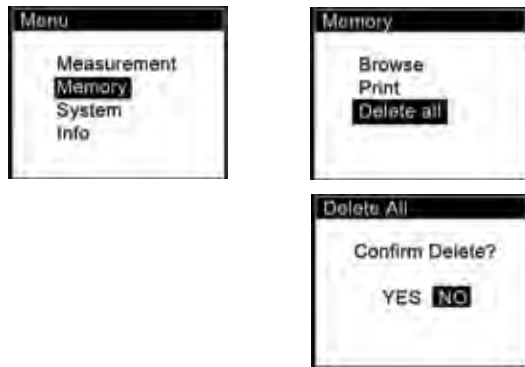

Fig. 4-4

### 5. SYSTEM

Under the System menu, the Display, Auto Power, Backlight, Key Sound, Date/Time, Calibration and Default sub menus are present.

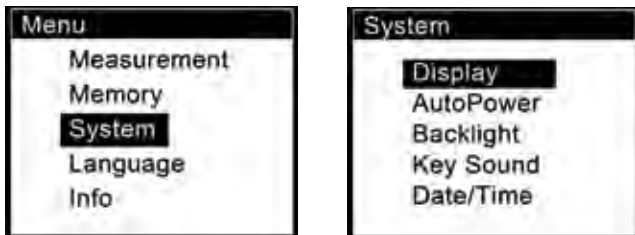

Fig. 5

#### 5.1 Display

There are two display modes: Obverse and Reverse (Fig. 5-1(a)). Obverse will allow the display to be up-right with the keypad underneath, while Reverse will allow the display to be up-right with the keypad above. Fig. 5-1(b)

#### 5.2 Auto Power

The FG-3000R has an automatic power off function. With Auto Power on, if there is no operation performed within five minutes it will power off automatically. (Fig. 5-2)



Fig. 5-2

#### 5.3 Backlight

The backlight can be set to turn on or off. See Fig.5-3. Choosing the backlight to be off will reduce the consumption of the battery.



Fig. 5-3

#### 5.4 Key Sound

The Key Sound can be turned on or off as shown in Fig. 5-4.



Fig. 5-4

#### 5.5 Date/time

Date and time can be adjusted under this menu. Press ZERO to adjust the number and press MODE to move to the next digit. Fig. 5-5



Fig. 5-5

## 5.6 Calibration

Because of the sensor material performance or the influence of external factors, there may be errors of a certain level after a period of usage.

It is recommended to send the force gauge to a specialized testing organization for calibration.

If you have standard force weights or other standard load and a test stand, you may utilize this function and procedure to calibrate the sensor.



Fig. 5-6(a)

- 1) Mount the force gauge.
- 2) Use the tare by use of the ZERO key.
- 3) Enter Calibration sub-menu as in Fig. 5-6(a).

The calibration interface is shown in Fig. 5-6(b).

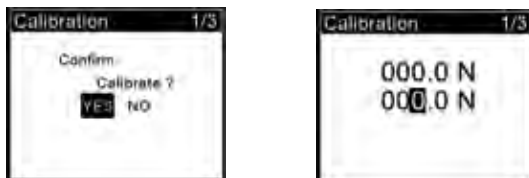

Fig. 5-6(b)

- 4) Load a standard force. Now the value in the standard input area is just equal to the current measured value. Wait a moment for the force to stabilize.

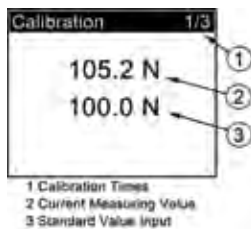

Fig. 5-6(c)

- 5) Press ZERO and MODE to input the standard force value.
- 6) Press MENU to enter the next calibration. Press LOG to interrupt the calibration.

When 3 calibration points have been finished, a confirm window will pop up asking to "Save and Exit"(YES)/(NO). Fig. 5-6(d)

Press ZERO or MODE to select, then press MENU.

If "YES" is selected, Calibration is complete. Fig. 5-6(e)

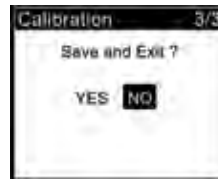

Fig. 5-6(d)

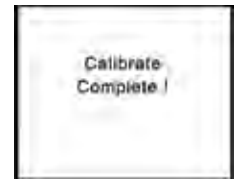

Fig. 5-6(e)

## 5.7 Default

With this function, the force gauge can be restored back to the original factory settings. Only perform this function when all other troubleshooting tactics have first been attempted.

## 6. LANGUAGE

The force gauge can display in various languages. Set the language as desired. See Fig. 6.



Fig. 6

## 7. INFO

Information about the force gauge such as range, version and serial number is provided in this menu. Fig. 7

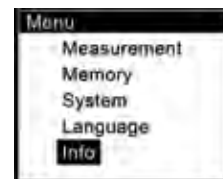

Fig. 7

## 8. COMMUNICATION PORT

The force gauge has a USB for recharging and communicating with a PC, plus an 8 pin connection for printer connection and set point output. Fig. 8-1

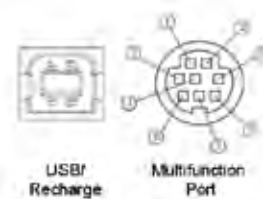

Fig 4-1

Pin#	Description
1	Tx
2	RS232 Rx
3	Gnd
4	Setpoint Output B
5	
6	Setpoint Output C (Common)
7	Setpoint Output A
8	

Fig. 8-1

The RS232 serial port is used to connect the mini-printer to print the memory data stored on the gauge.

**RS-232 Specifications:**

- Hardware Flow Control: None
- Data word length: 8 bits
- Stop bit: 1bit
- Parity: None
- Baud rate: 38400

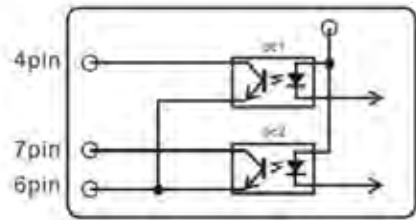

**Fig. 8-2**

**8.2 Setpoint Output**

Two NPN open collector setpoint outputs are available.

The internal circuit of the setpoint output is shown as Fig 8-2.

Pin7 with Pin6 will be connected when an overload alarm occurs.

In Preset Mode, Pin7 to Pin6 is connected when the measured value exceeds the upper limit. Pin4 to Pin6 is connected when the measured value passes below the lower limit.

**CAUTION: Maximum permissible voltage: pin 7 to 6, pin 4 to 6 must be lower than 35V ; pin 6 to 7, pin 6 to 4 must be lower than 6V .**

Remember to remove the load after measurement. Applying a load for a long time period may affect the accuracy of the instrument.

**9. MAINTENANCE**

**9.1 Maintenance**

After use, please keep the instrument body clean. Do not let oil and other substances persist on the body and screen so as not to damage the instrument. Remember to remove the load after measurement. Applying a load for a long time period may affect the accuracy of the instrument.

**9.2 Charging**

When the battery is low, the icon “  ” will be displayed. The batteries should be charged immediately.

Connect the gauge and the charger with the USB cable. Then connect the charger with AC socket to start charging.

**10. TROUBLESHOOTING**

According to the following table, review possible solutions for problems encountered. Do not disassemble the gauge by yourself or attempt to repair. If you cannot resolve the fault yourself, please contact Nidec-Shimpo.

Failure	Possible Causes	Potential Solutions
Unit will not turn on	Low battery	Recharge and then re-boot. If after 3-4 hours of charging time the battery does not properly hold a charge, the battery needs to be replaced. Contact Nidec-Shimpo.
No key sound	Key sound is turned off	Turn on the key sound in menu
No backlight	Backlight is turned off	Turn on the backlight in menu
Error is too large	The gauge is not calibrated	Calibration of force gauge is required. After calibration if the error remains outside of the specifications, sensor may be damaged. Contact Nidec-Shimpo to get RMA for return.

## 11. CAPACITY AND RESOLUTION

Model		N	kN	kgf	lbf	klbf
FG-3000R-1	Capacity	1000	1	100	220	
	Resolution	1	0.001	0.01	0.01	
FG-3000R-5	Capacity	5000	5	500	1100	
	Resolution	1	0.001	0.1	1	
FG-3000R-10	Capacity		10	1000	2250	
	Resolution		0.01	1	1	
FG-3000R-20	Capacity		20	2000	4500	
	Resolution		0.01	1	1	
FG-3000R-50	Capacity		50.0	5000		11
	Resolution		0.01	1		0.01

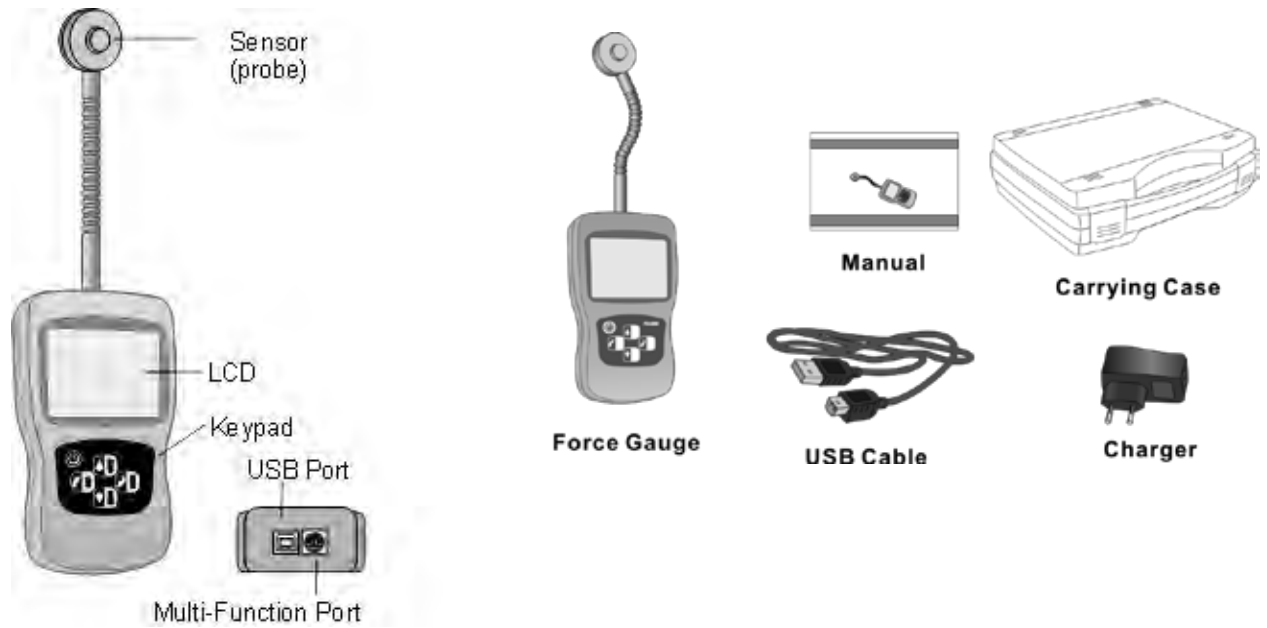

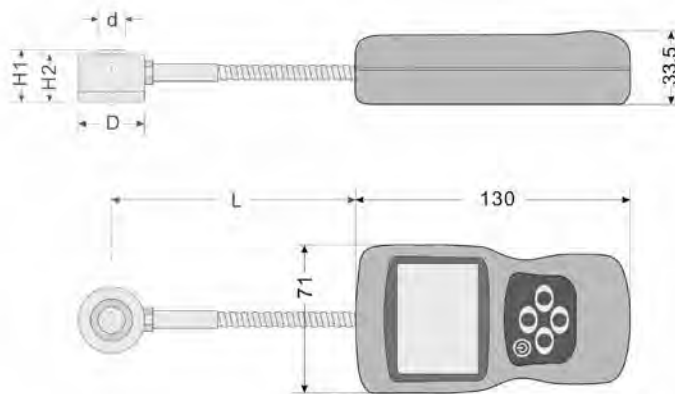
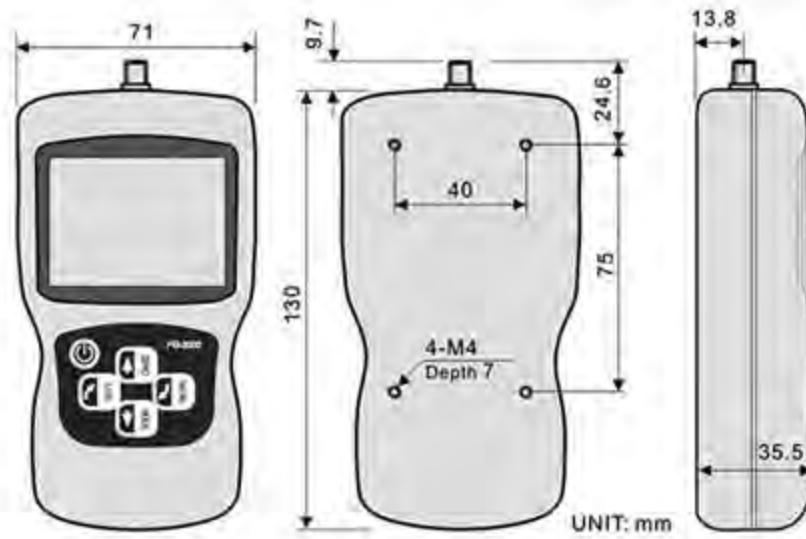

Unit:mm

Model	D	H1	H2	d	L
FG-3000R-1	Ø32	23	20.5	Ø8	222
FG-3000R-5					
FG-3000R-10					
FG-3000R-20	Ø38	24	22	Ø11	225
FG-3000R-50					