

Series 7

---

DIGITAL FORCE GAUGES

# User's Guide

**MARK-10<sup>®</sup>**

## Thank you...



Thank you for purchasing a Mark-10 Series 7 digital force gauge, designed for tension and compression testing applications from 0.12 lb to 1,000 lb (0.5 N to 5,000 N) full scale. The Series 7 is an essential component of a force testing system, typically also comprising a test stand, grips, and data collection software.

With proper usage, we are confident that you will get many years of great service with this product. Mark-10 force gauges are ruggedly built for many years of service in laboratory and industrial environments.

This User's Guide provides setup, safety, and operation instructions. Dimensions and specifications are also provided. For additional information or answers to your questions, please do not hesitate to contact us. Our technical support and engineering teams are eager to assist you.

**Before use, each person who is to use the Series 7 force gauge should be fully trained in appropriate operation and safety procedures. Safety features provided by these force gauges may be impaired if used in a manner not specified by Mark-10.**

## TABLE OF CONTENTS

OVERVIEW .....	2
POWER .....	3
SETUP .....	4
HOME SCREEN AND CONTROLS .....	5
DIGITAL FILTERS .....	7
SET POINTS .....	8
BREAK DETECTION.....	9
OPERATING MODES.....	11
DATA MEMORY AND STATISTICS .....	20
FOOTSWITCH .....	21
COEFFICIENT OF FRICTION .....	22
CUSTOM UNIT .....	23
COMMUNICATIONS AND OUTPUTS .....	23
CALIBRATION .....	29
PASSWORDS.....	33
OTHER SETTINGS.....	35
SPECIFICATIONS .....	37

## 1 OVERVIEW

### 1.1 List of included items

Qty.	Part No.			Description
	M7-012 – M7-20	M7-50 – M7-100	M7-200 – M7-500	
1	12-1049	12-1049	12-1049	Carrying Case
1	08-1022	08-1022	08-1022	AC adapter body with US, EU, or UK prong
1	08-1026	08-1026	08-1026	Battery (inside the gauge)
1	G1024	G1024	G1031	Extension rod
1	G1026	G1026	G1033	Cone
1	G1025	G1025	G1032	Chisel
1	G1027	G1027	G1034	V-groove
1	G1029	G1029	G1036	Flat
1	G1028	G1038	G1035	Hook
1	-	G1039	G1037	Coupling
1	-	-	-	Thread adapter
1	-	-	-	Certificate of calibration
1	09-1165	-	-	USB cable
-	USB driver, MESUR® Lite software, MESUR® gauge evaluation software, User's Guide			Download at: <a href="http://www.mark-10.com/resources">www.mark-10.com/resources</a>

### 1.2 Safety / Proper Usage

#### Caution!

**Note the force gauge's capacity before use and ensure that the capacity is not exceeded. Producing a force greater than 200% of the gauge's capacity can damage the internal load cell. An overload can occur whether the gauge is powered on or off.**

Typical materials suitable for testing include many manufactured items, such as springs, electronic components, fasteners, caps, films, mechanical assemblies, and many others. Items that should not be used with the gauge include potentially flammable substances or products, items that can shatter in an unsafe manner, and any other components that can present an exceedingly hazardous situation when acted upon by a force.

The following safety checks and procedures should be performed before and during operation:

1. Never operate the gauge if there is any visible damage to the AC adapter or the gauge itself.
2. Ensure that the gauge is kept away from water or any other electrically conductive liquids at all times.
3. The gauge should be serviced by a trained technician only. AC power must be disconnected and the gauge must be powered off before the housing is opened.
4. Always consider the characteristics of the sample being tested before initiating a test. A risk assessment should be carried out beforehand to ensure that all safety measures have been addressed and implemented.
5. Wear eye and face protection when testing, especially when testing brittle samples that have the potential to shatter under force. Be aware of the dangers posed by potential energy that can accumulate in the sample during testing. Extra bodily protection should be worn if a destructive failure of a test sample is possible.

6. In certain applications, such as the testing of brittle samples that can shatter, or other applications that could lead to a hazardous situation, it is strongly recommended that a machine guarding system be employed to protect the operator and others in the vicinity from shards or debris.
7. When the gauge is not in use, ensure that the power is turned off.

## 2 POWER

The gauge is powered either by an 8.4V NiMH rechargeable battery or by an AC adapter. Since the batteries are subject to self discharge, it may be necessary to recharge the unit after a prolonged period of storage. Plug the accompanying charger into the AC outlet and insert the charger plug into the receptacle on the gauge (refer to the illustration below). The battery will fully charge in approximately 8 hours.







### Caution!

**Do not use chargers or batteries other than supplied or instrument damage may occur.**

If the AC adapter is plugged in, an icon appears in the lower left corner of the display, as follows: 

If the AC adapter is not plugged in, battery power drainage is denoted in a five-step process:

1. When battery life is greater than 75%, the following indicator is present: 
2. When battery life is between 50% and 75%, the following indicator is present: 
3. When battery life is between 25% and 50%, the following indicator is present: 
4. When battery life is less than 25%, the following indicator is present: 
5. When battery life drops to approximately 2%, the indicator from step 4 will be flashing. Several minutes after (timing depends on usage and whether the backlight is turned on or off), a message appears, "BATTERY VOLTAGE TOO LOW. POWERING OFF". An audio tone will sound and the gauge will power off.

The gauge can be configured to automatically power off following a period of inactivity. Refer to the **Other Settings** section for details.

If battery replacement is necessary, it can be accessed by separating the two halves of the gauge. Refer to the **Setup** section for details.

## 3 SETUP

### 3.1 Mechanical Setup

#### 3.1.1 Loading shaft orientation

In order to accommodate a variety of testing requirements, the orientation of the loading shaft may be set up in either of the two positions shown below. In order to change the loading shaft orientation, loosen two captive screws on the back side of the housing, separate the two housing halves, rotate one half 180 degrees, and reassemble. Contact between the two halves is made by spring pins and contact pads on the printed circuit boards.

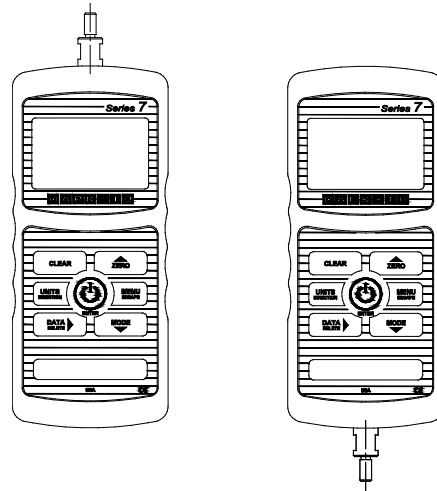

Load cell shaft up

Load cell shaft down

#### 3.1.2 Mounting to a plate

Proper mounting is important if attached to a fixture or test stand. The round steel insert with a hole in the back of the housing is provided to withstand the load during a test. A mating dowel pin should be used (see illustration below). Mounting plates on Mark-10 test stands include a dowel pin and clearance holes for the four threaded holes located near the corners of the housing. These holes are designed to accommodate screws in order to hold the gauge in place (Mark-10 test stands include a set of thumb screws for gauge mounting). The screws must **not** be used for load bearing purposes. Failure to use a dowel pin properly can result in a hazardous situation.

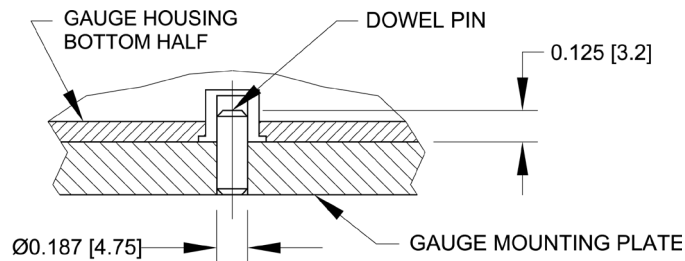

#### 3.1.3 Mounting attachments to the gauge

The force gauge's threaded loading shaft is designed to accommodate common grips and attachments with female mounting holes. To mount a grip, gently thread it onto the shaft. Other mounting adapters are also available to prevent rotation. Ensure that the grip or fixture is positioned to ensure axial load with respect to the loading shaft of the force gauge. When using a grip, ensure that it secures the sample in such a way that it is prevented from slipping out during a test, preventing a potential safety risk to the operator and others in the vicinity. If using a grip or fixture from a supplier other than Mark-10, ensure that it is constructed of suitably rugged materials and components.

Do not use jam nuts or tools to tighten grips or attachments onto the shaft. **Finger-tighten only.**

### 3.2 Installing the USB driver

If communicating via USB, install the USB drivers available at: [www.mark-10.com/downloads](http://www.mark-10.com/downloads)

#### Caution!

**Install the USB driver before physically connecting the gauge to a PC with the USB cable.**

Further instructions for configuring and using the gauge's outputs are provided in the **Communications and Outputs** section.

## 4 HOME SCREEN AND CONTROLS



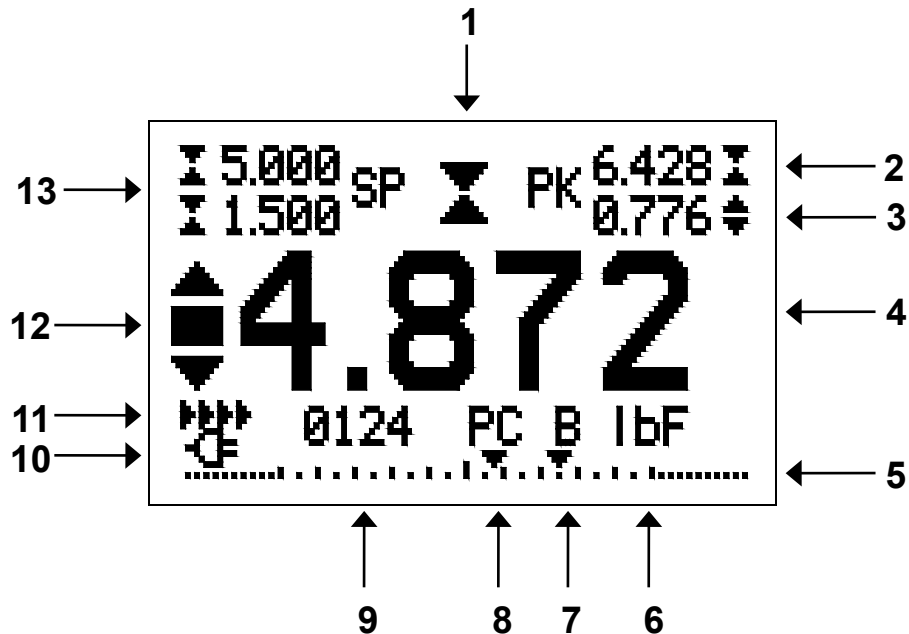

### 4.1 Home Screen







No.	Name	Description
1	Tension / compression indicator	- indicates a compression (push) direction - indicates a tension (pull) direction These indicators are used throughout the display and menu.
2	Compression Peak	The measured compression peak reading. This reading may be reset by pressing <b>ZERO</b> or by powering the gauge off and on.
3	Tension Peak / Static COF	The measured tension peak. If the COF unit is selected, this represents the static coefficient of friction. May be reset by pressing <b>ZERO</b> or by powering the gauge off and on.
4	Primary reading / Kinetic COF	The current displayed force reading. When the COF unit is selected, this reading represents the kinetic coefficient of friction upon completion of an <b>Averaging</b> sequence. See <b>Operating Modes</b> section for details.

5	Load bar	Analog indicator to help identify when an overload condition is imminent. The bar increases either to the right or to the left from the midpoint of the graph. Increasing to the right indicates compression load, increasing to the left indicates tension load. If set points are enabled, triangular markers are displayed for visual convenience. This indicator reflects the actual load, which may not correspond to the primary reading (depends on operating mode). The <b>ZERO</b> key does not reset the load bar. See <b>Operating Modes</b> section for details.
6	Units	The current unit of measurement. Abbreviations are as follows: lbF – Pound-force ozF – Ounce-force kgF – Kilogram-force gF – Gram-force N – Newton kN – Kilonewton mN – Millinewton COF – Coefficient of friction XXXXX – User-defined unit (up to 5 characters) <b>Note:</b> not all gauge capacities measure in all the above units. Refer to the capacity / resolution table in the <b>Specifications</b> section for details. COF and user-defined units must be enabled before they can be selected.
7	Break Detection On/Off	The letter "B" appears if the Break Detection function is enabled. Refer to the <b>Break Detection</b> section for details.
8	Mode	The current measurement mode. Abbreviations are as follows: RT – Real Time PC – Peak Compression PT – Peak Tension (corresponds to static COF) A – Average (corresponds to kinetic COF) ET – External Trigger CAPT – Data Capture 2PK – 1 <sup>st</sup> /2 <sup>nd</sup> Peak See <b>Operating Modes</b> section for details.
9	Number of stored data points	The number of stored data points in memory, up to 5,000. Displayed only if <b>Memory Storage</b> or <b>Data Capture</b> functions are used.
10	Battery / AC adapter indicator	Either the AC adapter icon or battery power icon will be shown, depending on power conditions. Refer to the <b>Power</b> section for details.
11	Automatic data output indicator	If <b>Auto Output</b> has been enabled under <b>Serial / USB Settings</b> , this indicator is displayed. When automatic data output is occurring, the icon becomes animated. See <b>Communications and Outputs</b> section for details.
12	High / low limit indicators	Correspond to the programmed set points. Indicator definitions are as follows: ▲ – the displayed value is greater than the upper force limit ■ – the displayed value is between the limits ▼ – the displayed value is less than the lower force limit
13	Set points	The programmed force limits. Typically used for pass/fail type testing. 1, 2, or no indicators may be present, depending on the configuration shown in the <b>Set Points</b> menu item.



## 4.2 Controls

43	Primary Function	Secondary Label	Secondary Function
	Powers the gauge on and off. Press briefly to power on, press and hold to power off. Active only when the home screen is displayed.	<b>ENTER</b>	Various uses, as described in the following sections.
<b>ZERO</b>	Zeroes the primary reading and peaks.	 <b>(UP)</b>	Navigates up through the menu and sub-menus.
<b>MENU</b>	Enters the main menu.	<b>ESCAPE</b>	Reverts one step backwards through the menu hierarchy.
<b>MODE</b>	Toggles between measurement modes.	 <b>(DOWN)</b>	Navigates down through the menu and sub-menus.
<b>DATA</b>	Stores a value to memory, transmits the current reading to an external device, and/or initiates automatic data output, depending on setup.	<b>DELETE</b> 	Enables and disables <b>Delete</b> mode while viewing stored data / shifts cursor to the right for certain functions.
<b>UNITS</b>	Toggles between measurement units.	<b>DIRECTION</b>	Reverses the display during calibration, and toggles between tension and compression directions while configuring set points and other menu items.
<b>CLEAR</b>	Zeroes the peak readings, but retains the primary reading.	<b>N/A</b>	N/A

### 4.3 Menu navigation basics

Most of the gauge's various functions and parameters are configured through the main menu. To access the menu press **MENU**. Use the  and  keys to scroll through the items. The current selection is denoted with clear text over a dark background. Press **ENTER** to select a menu item, then use  and  again to scroll through the sub-menus. Press **ENTER** again to select the sub-menu item.

For parameters that may be either selected or deselected, press **ENTER** to toggle between selecting and deselecting. An asterisk (\*) to the left of the parameter label is used to indicate when the parameter has been selected.

For parameters requiring the input of a numerical value, use the  and  keys to increment or decrement the value. Press and hold either key to auto-increment at a gradually increasing rate. When the desired value has been reached, press **ENTER** to save the change and revert back to the sub-menu item, or press **ESCAPE** to revert back to the sub-menu item without saving. Press **ESCAPE** to revert one step back in the menu hierarchy until back into normal operating mode.

Refer to the following sections for details about setting up particular functions and parameters.

## 5 DIGITAL FILTERS

Digital filters are provided to help smooth out the readings in situations where there is mechanical interference in the work area or test sample. These filters utilize the moving average technique in which consecutive readings are pushed through a buffer and the displayed reading is the average of the buffer contents. By varying the length of the buffer, a variable smoothing effect can be achieved. The selection of 1 will disable the filter since the average of a single value is the value itself.

To access digital filter settings, select **Filters** from the menu. The display appears as follows:



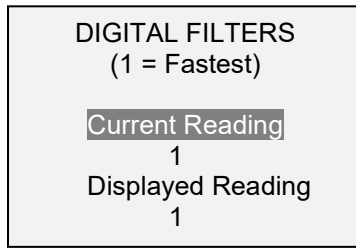

Two filters are available:

**Current Reading** – Applies to the peak capture rate of the instrument.

**Displayed Reading** – Applies to the primary reading on the display.

Available settings: 1, 2, 4, 8, 16, 32, 64, 128, 256, 512, 1024, 2048, 4096, 8192. It is recommended to keep the current reading filter at its lowest value for best performance, and the displayed reading filter at its highest value for best visual stability.

## 6 SET POINTS

### 6.1 General Information

Set points are useful for tolerance checking (pass/fail), triggering an external device such as a motorized test stand, or alarm indication in process control applications. Two limits, high and low, are specified and stored in the non-volatile memory of the instrument and the primary reading is compared to these limits. The results of the comparisons are indicated through the three outputs provided on the 15-pin connector, thus providing “under”, “in range”, and “over” signaling. These outputs can be connected to indicators, buzzers, or relays as required for the application.

### 6.2 Configuration

To configure set points, select **Set Points** from the menu. The screen appears as follows:

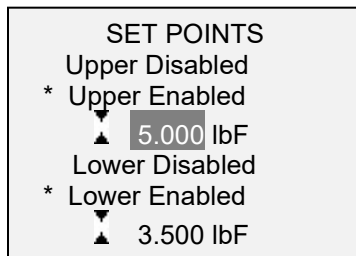

One, two, or none of the set points may be enabled. To toggle between the tension and compression directions, press the **DIRECTION** key.

If two set points have been enabled, they are displayed in the upper left corner of the display. If only one set point has been enabled, the word “OFF” appears in place of the value. If no set points have been enabled, the upper left corner of the display will be blank.

When set points are enabled, the following indicators are shown to the left of the primary reading:

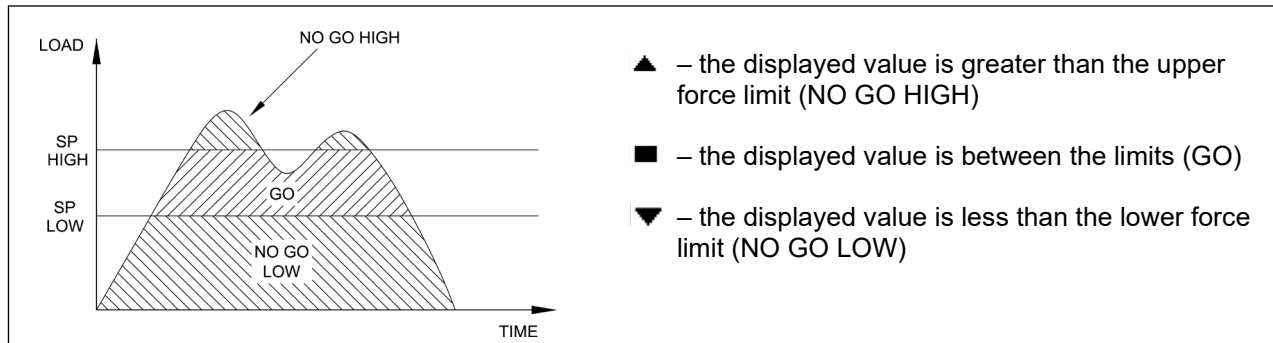

**Note:** Set point indicators and outputs reference the displayed reading, not necessarily the current live load.

### 6.2.1 Set Point Outputs Schematic Diagram

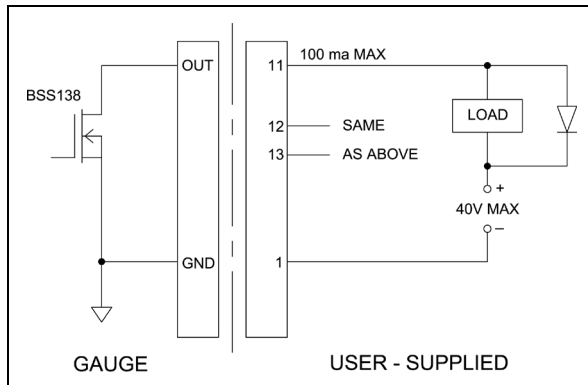

### 6.3 Using Set Points to Control Mark-10 Motorized Test Stands

When using set points to stop/cycle crosshead motion on certain Mark-10 test stands, the upper set point must always be a value in the **tension** direction, and the lower set point must always be a value in the **compression** direction. **Both** set points must be set, even if the intended application is to stop/cycle at only one of the set points. The opposite set point should be a value sufficiently large that it does not get triggered during the course of the test.

For certain other Mark-10 test stands, the tension and compression directions are reversed.

## 7 BREAK DETECTION

The break detection function identifies when a sample has broken, clicked, slipped, or otherwise reached a peak force and then fell by a specified percentage drop. Upon detection of the break, the gauge can perform several automatic functions, depending on the mode in which break detection is enabled, as follows:

1. Transmit the peak reading (Auto Output).
2. Save the peak value to memory (Auto Storage).
3. Zero the primary and peak readings (Auto Zero).
4. Toggle a pin (for example, to stop crosshead movement on a Mark-10 motorized test stand).

Break detection functions and settings are configured from a central location, and apply to any mode in which it is enabled. Refer to the **Operating Modes** section for details on configuring each mode.

## 7.1 Configuration

To enable Break Detection and configure the automatic functions, select **Break Detection** from the main menu. The display appears as follows:

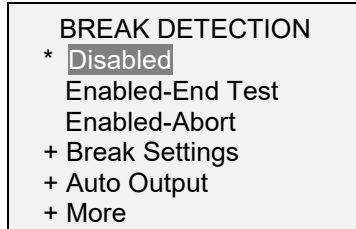

Select "+ More" for additional options:

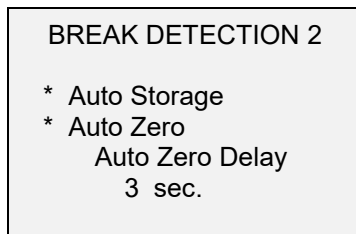

Any combination of the above functions may be selected.

Function	Description
<b>Enabled-End Test</b>	Arms the break detection function. When enabled, the letter "B" will appear on the home screen, between the Mode and Unit indicators. Refer to the <b>Home Screen and Controls</b> section for details. Applies to modes in which a <i>Break Detect Stop Condition</i> is specified.
<b>Enabled-Abort</b>	Same as above, except applies to situations in which a premature break occurs before the specified <i>Stop Condition</i> is reached.
<b>Break Settings</b>	Refer to the following sub-sections for details.
<b>Auto Output</b>	
<b>Auto Storage</b>	Automatically stores the peak reading to memory.
<b>Auto Zero</b>	Automatically zeroes the display following data transmission and/or storage.

If tones are enabled, a tone will sound when the output, storage, and zero functions have occurred.

## 7.2 Break Settings

Select **Break Settings** from the **Break Detection** menu to configure the settings. The display appears as follows:

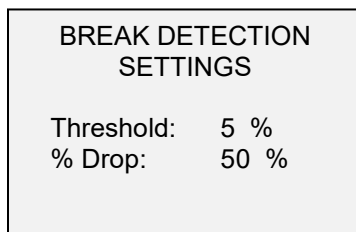

<b>Threshold</b>	Sets the percentage of full scale at which the break detection function becomes active. This threshold is provided to ignore peaks that can occur during sample loading and unloading. <i>Available settings: 1–90%, in 1% increments until 5%, 5% increments thereafter.</i>
<b>% Drop</b>	Sets the percentage drop from the peak reading at which the break is detected. <i>Available settings: 5%–90% of peak, in 5% increments.</i>
<b>Auto Zero Delay</b>	Sets the time delay before the primary and peak readings are zeroed. Auto zero can be disabled if required. Refer to the <b>Auto Output Settings</b> sub-section for details. <i>Available settings: 1–10 sec. in 1 sec. increments, and 10–60 sec. in 5 sec. increments.</i>

**Note:**

When using a Series 7 gauge with an ESM303, ESM303H, or ESM1500 equipped with **Break Detection**, enable the function in either the test stand or the instrument. The function will not work if simultaneously enabled in both devices.

**7.3 Auto Output Settings**

Scroll to **Auto Settings** in the **Break Detection** menu and press **ENTER** to configure the auto output settings. Any combination may be selected. The display appears as follows:



Parameter	Description
<b>RS232/USB Output</b>	Automatically output the peak when the break (% Drop) is detected.
<b>Mitutoyo Output</b>	Automatically output the peak when the break (% Drop) is detected.
<b>Output Pin</b>	Automatically toggle the SP1, SP2, or SP3 pins (active low). If not required, select "NONE". To stop certain Mark-10 test stands when a break occurs, specify SP2 if the break is in the tension (upwards) direction, or SP1 for the compression (downwards) direction. <b>Note:</b> Because the same pins are also used for set points, the stand will stop at whichever condition occurs first.

**8 OPERATING MODES****Caution!**

In any operating mode, if the capacity of the instrument has been exceeded by more than 110%, the display will show "OVER" to indicate an overload. A continuous audible tone will be sounded until the MENU key has been pressed or the load has been reduced to a safe level.

Several operating modes are possible with Series 7 gauges, as follows:

- **Real Time (RT)**
- **Peak Compression (PC)**
- **Peak Tension / Static Coefficient of Friction (PT)**
- **Average Mode / Kinetic Coefficient of Friction (AVG)**

- **External Trigger (ET)**
- **Data Capture (CAPT)**
- **1<sup>st</sup>/2<sup>nd</sup> Peak (2PK)**

To cycle between the modes, press **MODE** while in the home screen. Refer to the following sections for details for each mode:

### 8.1 Real Time (RT)

The primary reading corresponds to the live measured reading.

### 8.2 Peak Compression (PC)

The primary reading corresponds to the peak compression reading observed. If the actual force decreases from the peak value, the peak will still be retained in the primary reading area of the display. Pressing **ZERO** will reset the value.

### 8.3 Peak Tension / Static Coefficient of Friction (PT)

This is the same as Peak Compression, but for tension readings. If the COF unit is selected, the reading in this mode represents the static coefficient of friction.

**Note:** The static COF is always displayed as the peak tension value in the upper right corner of the display.

### 8.4 Average Mode / Kinetic Coefficient of Friction (AVG)

Average mode is used to obtain an average force reading over time. This reading also represents the kinetic coefficient of friction, if the COF unit is selected. Applications include measurement of peel force, COF, muscle strength, frictional force, and other tests requiring time-averaged readings.

Before the parameters of Average Mode can be configured, it must be enabled. To do so, select **Average Mode** from the menu, scroll to **Enabled** and press **ENTER**. The display appears as follows:

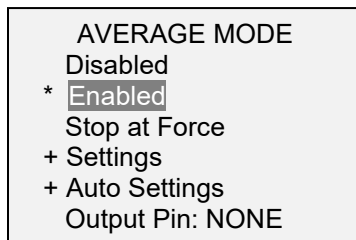

The averaging function operates in one of two ways:

1. Averaging occurs between the trigger force and defined time limit, as illustrated below:

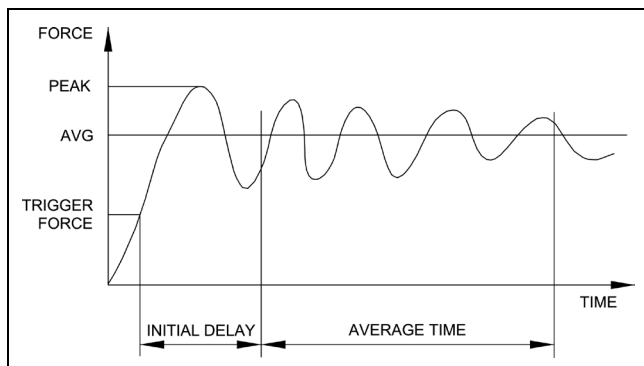

- Averaging occurs only while above the trigger force. As the force drops back down to this trigger, averaging stops. To enable this function, scroll to **Stop at Force** and press **ENTER**.

Select **Settings** to configure **Trigger Force**, **Initial Delay**, and **Averaging Time**:

AVERAGE MODE SETTINGS	
Trigger Force	▼ 1.00 lbf
Initial Delay	1.0 sec.
Averaging Time	5.0 sec.

Parameter	Description
<b>Trigger Force</b> or <b>Start / Stop Force</b>	The minimum force required to start the averaging sequence. Toggle between compression and tension directions by pressing the <b>DIRECTION</b> key. Initial delay follows the trigger force. If <b>Stop at Force</b> is enabled, this parameter is referred to as <b>Start / Stop Force</b> , denoting the minimum force for which averaging will be active.
<b>Initial Delay</b>	The time delay, after the trigger force, before the averaging sequence commences. <i>Available settings: 0.0 – 300.0 sec., in 0.1 sec. increments</i>
<b>Averaging Time</b>	The time duration of the averaging sequence. This setting is ignored when <b>Stop at Force</b> is enabled, unless the 300 sec. limit is reached. <i>Available settings: 0.1 – 300.0 sec., in 0.1 sec. increments</i>

Upon completion of an averaging sequence, several automatic functions can occur, as configured in the **Auto Settings** section:

AUTO SETTINGS	
* RS232/USB Output	
* Mitutoyo Output	
* Memory Storage	
* Auto Zero	
Auto Zero Delay	5 sec.

Parameter	Description
<b>RS232/USB Output</b>	Automatically output the average via RS-232 or USB at the completion of the averaging sequence.
<b>Mitutoyo Output</b>	Automatically output the average via Mitutoyo (Digimatic) at the completion of the averaging sequence.
<b>Memory Storage</b>	Automatically store the average at the completion of the averaging sequence.
<b>Auto Zero</b>	Automatically zero the reading at the completion of the averaging sequence. This re-arms the gauge for a new averaging sequence as if <b>ZERO</b> has been pressed.
<b>Auto Zero Delay</b>	The amount of time before the auto-zero occurs, in seconds: <i>Available settings: 1-10 sec., in 1 sec. increments, and 10-60 sec., in 5 sec. increments.</i>
<b>Output Pin</b>	Automatically toggle the SP1, SP2, or SP3 pins (active low). If not required, select "NONE". To stop a Mark-10 test stand when averaging is completed, specify SP2 if moving in the tension (upwards) direction, or SP1 for the compression (downwards) direction.

	<b>Note:</b> Because the same pins are also used for set points, the stand will stop at whichever condition occurs first.
--	---

After the parameters have been configured and the menu has been exited, press **MODE** until **AVG** is displayed. Then press **ZERO**. Average mode is now armed, and the averaging sequence will commence when the trigger force has occurred. The current status of the averaging sequence is displayed below the primary reading, as follows:

Step	Status	Description
1	TRIG WAIT	The trigger force has not yet occurred.
2	INIT DLY	The initial delay is currently taking place.
3	AVERAGING	The gauge is collecting readings. The status will be flashing until averaging has been completed.
4	AVRG DONE	Averaging has been completed. The average force is displayed in the primary reading.

At the completion of the averaging sequence, the peak values are retained until **ZERO** is pressed. Another averaging sequence may be started after **ZERO** has been pressed (or auto-zeroed). To exit Average mode, press **MODE** and select the desired measuring mode.

### 8.5 External Trigger (ET)

This mode of operation is useful for measuring electrical contact activation force as well as synchronization of multiple instruments for a “snapshot” view of applied forces. It is possible to capture the reading with a normally open contact (high to low transition of the trigger signal) or a normally closed contact (low to high transition). Certain Mark-10 test stand may be automatically stopped when an external trigger has occurred.

Before the parameters of External Trigger Mode can be configured, it must be enabled. To do so, access the main menu, select **External Trigger**, scroll to one of the four available options and press **ENTER**. The options are as follows:

EXTERNAL TRIGGER
* Disabled
Momentary Hi->Lo
Momentary Lo->Hi
Maintained High
Maintained Low
+ More

Select “+ More” for additional options:

EXTERNAL TRIGGER 2
+ Auto Settings
Output Pin: NONE

Option	Description
<b>Momentary High → Low</b>	The display will freeze the captured reading until <b>ZERO</b> is pressed. Applies to a high to low transition of the trigger signal.
<b>Momentary Low → High</b>	The display will freeze the captured reading until <b>ZERO</b> is pressed. Applies

	to a low to high transition of the trigger signal.
<b>Maintained High</b>	The display will show the captured reading only for as long as a high signal is maintained.
<b>Maintained Low</b>	The display will show the captured reading only for as long as a low signal is maintained.
<b>Auto Settings</b>	Functions exactly as described in Section 5.4. These parameter values are shared between Averaging and External Trigger modes.
<b>Output Pin</b>	Automatically toggle the SP1, SP2, or SP3 pins (active low). If not required, select "NONE". To stop certain Mark-10 test stands when an external trigger occurs, specify SP2 if moving in the tension (upwards) direction, or SP1 for the compression (downwards) direction. <b>Note:</b> Because the same pins are also used for set points, the stand will stop at whichever condition occurs first.

After the parameters have been configured and the menu has been exited, press **MODE** until **ET** is displayed. External Trigger mode is now armed. Refer to the pin diagram in the **Communications and Outputs** section for connection information.

To exit External Trigger mode, press **MODE** and select the desired measuring mode.

### 8.5.1 External Trigger Schematic Diagram

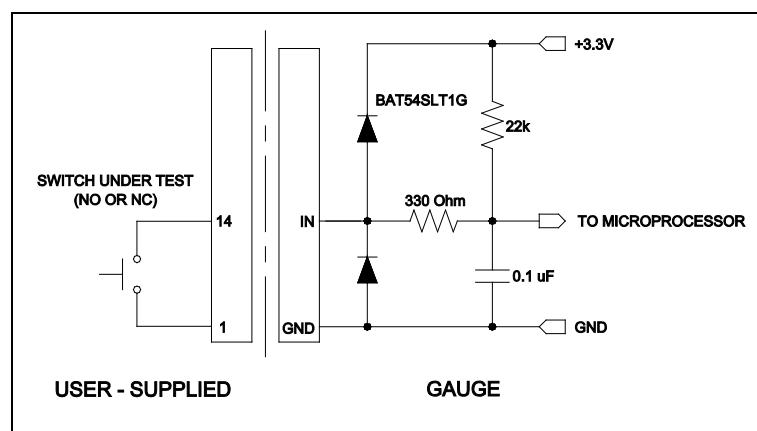

**Note:** Custom cabling is required to connect to a switch, or to connect a switch and a Mark-10 test stand simultaneously.

## 8.6 Data Capture (CAPT)

This mode of operation is used to capture and store continuous data in the gauge's memory. The capture frequency can be adjusted to accommodate quick-action as well as longer duration tests. Saved data can be downloaded in bulk via USB or RS-232.

### 8.6.1 Configuration

After Data Capture has been enabled, it may be selected by pressing the **MODE** key until **CAPT** is displayed. The display appears as follows:



<p>DATA CAPTURE</p> <p>* <b>Enabled</b></p> <p>Period (H:M:S.x)</p> <p>00 :00 :00 .00007</p> <p>+ Start Condition</p> <p>+ Stop Condition</p> <p>+ Auto Settings</p>
--

Function	Description
<b>Enabled</b>	If enabled, <b>CAPT</b> appears as one of the operating modes.
<b>Period</b>	The capture period may be adjusted by pressing the ▲ and ▼ keys to change the value of the hours (H), minutes (M), seconds (S), and fractions of seconds (x) fields. Press the ▶ key to advance to the next field. Available settings: <i>Hours: 0-24, Minutes: 0-59, Seconds: 0-59, Fraction of Seconds: 0.00007-0.99995, in 0.00007 (70 μS) increments.</i>
<b>Start Condition</b>	See following sub-sections for details.
<b>Auto Settings</b>	

**Note:** For best performance, it is recommended to keep the current reading filter at its lowest value. See **Digital Filters** section for details.

### 8.6.2 Start Condition

Data capture is initiated when the Start Condition has been triggered. Several triggers are available, as shown below:

<p>START CONDITION</p> <p>Momentary Hi→Lo</p> <p>Momentary Lo→Hi</p> <p>* Maintained High</p> <p>Maintained Low</p> <p>+ More</p>
---

Select "+ More" for additional options:

<p>START CONDITION 2</p> <p><b>Start Force</b></p> <p>▲ ▼ 3.500 lbF</p> <p>* DATA Key</p>
---

Function	Data capture is initiated when:
<b>Momentary Hi→Lo</b>	An external trigger occurs. See <b>External Trigger</b> sub-section for details for each of these functions.
<b>Momentary Lo→Hi</b>	
<b>Maintained High</b>	
<b>Maintained Low</b>	
<b>Start Force</b>	The desired trigger force is reached. Toggle between compression and tension directions by pressing the <b>DIRECTION</b> key.
<b>DATA Key</b>	The <b>DATA</b> key is manually pressed.

### 8.6.3 Stop Condition

Data capture is automatically terminated when the Stop Condition has been reached. Several conditions are available, as shown below:

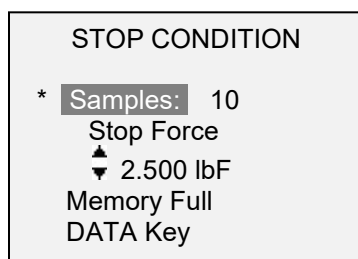

Function	Data capture terminates when:
<b>Samples</b>	The desired number of samples (data points) has been captured.
<b>Stop Force</b>	The desired force has been reached.
<b>Memory Full</b>	5,000 data points have been captured.
<b>DATA Key</b>	The <b>DATA</b> key is manually pressed.

When data capture has stopped, the data may be automatically transmitted in bulk to a PC application (not supported by Mark-10 data collection software). Data may also be transmitted manually through the **Memory** section.

**Note 1:** If the Stop Condition does not occur, data capture stops automatically when the memory is full.

**Note 2:** Data capture may be manually stopped at any time by pressing the **ZERO** key. A message will appear at the bottom of the screen: "CAPTURE CANCELLED".

The first or subsequent Data Capture sequences cannot occur until the **ZERO** key is pressed to arm data capture, or until the gauge is automatically re-armed (see the following sub-section for details). If another Data Capture sequence is initiated before the memory is cleared, these data points are appended to the existing data stored in memory.

### 8.6.4 Auto Settings

The following functions can occur automatically upon termination of data capture:

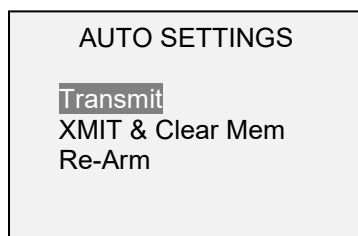

Function	Description
<b>Transmit</b>	Transmit all saved data via USB or RS-232.
<b>XMIT &amp; Clear Mem</b>	Transmit all saved data via USB or RS-232, and clear the memory.
<b>Re-Arm</b>	Re-arm the gauge for the next Data Capture sequence.

### 8.7 First / Second Peak (2PK)

This function is designed to accurately capture first and second peaks which can occur in materials testing and other applications.

### 8.7.1 Configuration

Several functions can be performed automatically upon detection of the second peak:

1. Transmit the first peak reading and/or...
2. Transmit the second peak reading and/or...
3. Save the first peak value to memory and/or...
4. Save the second peak value to memory and/or...
5. Zero the peak readings and/or...
6. Toggle an output pin

These automatic functions can help automate and expedite testing processes. If tones are enabled, an audible tone will sound when the output, storage, and zero functions have occurred. In order for First / Second Peak detection to be active, the appropriate operating mode must be selected. See the **Operating Modes** section for details. The display appears as follows:

FIRST/SECOND PEAK
* Enabled
+ Peak Settings
+ Auto Output
* Auto Store PK1
* Auto Store PK2
* Auto Zero

Any combination of the above functions may be selected.

Function	Description
<b>Enabled</b>	If enabled, <b>2PK</b> appears as one of the operating modes. In the main display, the Peak readings will reference the first and second peaks – first peak on top, second peak below. Refer to the <b>Home Screen &amp; Controls</b> section for details.
<b>Peak Settings</b>	See following sub-sections for details.
<b>Auto Output</b>	
<b>Auto Store PK1</b>	Automatically stores the first peak reading to memory.
<b>Auto Store PK2</b>	Automatically stores the second peak reading to memory.
<b>Auto Zero</b>	Automatically zeroes the display following data transmission and/or storage.

### 8.7.2 Peak Settings

The display appears as follows:

PEAK SETTINGS	
Threshold 1:	5 %
% Drop 1:	10 %
Threshold 2:	5 %
% Drop 2:	10 %
Auto Zero Delay	
	3 sec.

<b>Threshold 1</b>	Sets the percentage of full scale at which the first/second peak detection feature becomes active. This threshold is provided to ignore peaks that can occur during sample loading and unloading. Available settings: 1–90%, in 1% increments between 1–5%, and in 5% increments between 5–90%.
<b>% (Percentage) Drop 1</b>	Identifies the first peak via detection of a specified percentage drop from peak. Available settings: 5–95% of peak, in 5% increments.
<b>Threshold 2</b>	Same as Threshold 1, but refers to a percentage increase above the load associated with the first peak percentage drop.

<b>% (Percentage) Drop 2</b>	Same as Percentage Drop 1 but for the second peak.
<b>Auto Zero Delay</b>	Sets the time delay before the peak readings are zeroed. Available settings: 1–10 sec. in 1 sec. increments, and 10–60 sec. in 5 sec. increments.

Thresholds and percentage drops are illustrated below:

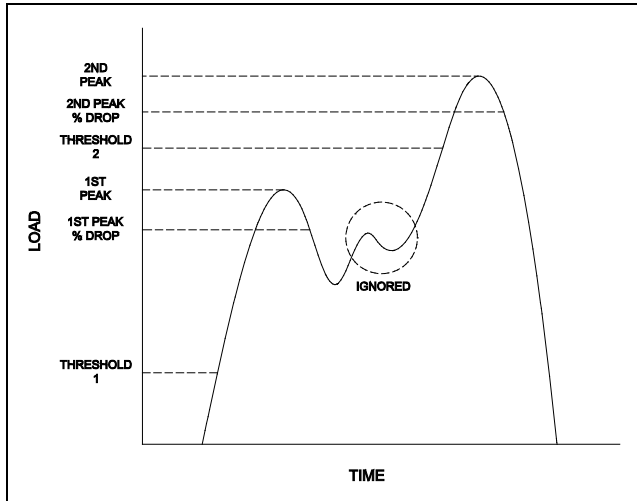

### 8.7.3 Auto Output Settings

Scroll to **Auto Output Settings** and press **ENTER** to select the desired automatic outputs. Select RS-232/USB and/or Mitutoyo outputs, and select First and/or Second peaks, and an Output Pin, if desired. The display appears as follows:



Parameter	Description
<b>RS232/USB Output</b>	Automatically output the selected peak(s) after the 2 <sup>nd</sup> peak is detected.
<b>Mitutoyo Output</b>	Automatically output the selected peak(s) after the 2 <sup>nd</sup> peak is detected.
<b>First Peak</b>	Automatically output the first peak.
<b>Second Peak</b>	Automatically output the second peak.
<b>Output Pin</b>	Automatically toggle the SP1, SP2, or SP3 pins (active low). If not required, select "NONE". To stop certain Mark-10 test stands when a 1 <sup>st</sup> /2 <sup>nd</sup> peak capture sequence is completed, specify SP2 if moving in the tension (upwards) direction, or SP1 for the compression (downwards) direction. <b>Note:</b> Because the same pins are also used for set points, the stand will stop at whichever condition occurs first.

## 9 DATA MEMORY AND STATISTICS

Series 7 gauges have storage capacity of 5,000 data points. Readings may be stored, viewed, and output to an external device. Individual or all data points may be deleted. Statistics are calculated for the data in memory.

To enable memory storage, select **DATA Key** from the menu, then scroll to **Memory Storage** and press **ENTER**. Then exit the menu. In the home screen, the data record number **0000** appears below the primary reading. Press **DATA** at any time to save the displayed reading. The record number will increment each time **DATA** is pressed. If **DATA** is pressed when memory is full the message “MEMORY FULL” will be flashed at the bottom of the display and a double audio tone will be sounded.

To view, edit, and output stored readings and statistics, select **Memory** from the menu. The screen appears as follows:

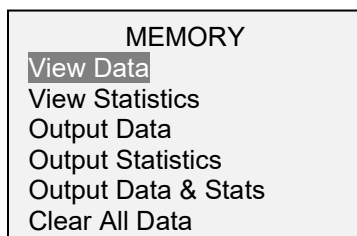

### 9.1 View Data

All the saved data points may be viewed. The record number is displayed, along with the corresponding value and currently set unit of measurement. Any readings may be deleted individually. To do so, scroll to the desired reading and press **DELETE**. The letter “D” appears to the left of the record number, indicating that the gauge is in **Delete** mode, as follows:

0001	2.458 lbF
0002	2.224 lbF
0003	2.446 lbF
0004	1.890 lbF
D 0005	2.098 lbF
0006	1.998 lbF
0007	2.042 lbF

Press **ENTER** to delete the value. To exit **Delete** mode, press **DELETE** again. Any number of readings may be individually deleted, however, all readings may also be cleared simultaneously. Refer to the **Clear All Data** section for details.

### 9.2 Statistics

Statistical calculations are performed for the saved values. Calculations include number of readings, minimum, maximum, mean, and standard deviation.

### 9.3 Output Data

Press **ENTER** to output data to an external device. The display will show, “SENDING DATA...”, then “DATA SENT”. If there was a problem with communication, the display will show, “DATA NOT SENT”. Saved data can be transmitted to a data collection program such as MESUR™gauge. Refer to their respective user's guides for details.

### 9.4 Output Statistics

Press **ENTER** to output statistics to an external device. The display will show, “SENDING STATS...”, then “STATS SENT”. If there was a problem with communication, the display will show, “STATS NOT SENT”.

### 9.5 Output Data & Stats

Press **ENTER** to output data and statistics to an external device. The display will show, "SENDING DATA", then "SENDING STATS...", then "DATA SENT", then "STATS SENT". If there was a problem with communication, the display will show, "DATA NOT SENT" and/or "STATS NOT SENT".

### 9.6 Clear All Data

Press **ENTER** to clear all data from the memory. A prompt will be shown, "CLEAR ALL DATA?". Select **Yes** to clear all the data, or **No** to return to the sub-menu.

*Shortcut for clearing all data:* In the main menu, highlight **Memory** and press **DELETE**. The same prompt will be shown as above.

For output of data and/or statistics, RS-232 or USB output must be enabled. Data formatting is <CR><LF> following each value. Units can be either included or excluded. Output of data via the Mitutoyo output is possible; however, output of statistics is not. Refer to the **Communications and Outputs** section for details.

**Note:** Data is not retained while the gauge is powered off. However, the gauge protects against accidental or automatic power-off. If manually powering the instrument off, or if the inactivity time limit for the **Automatic Shutoff** function has been reached, the following warning message appears:



If no option is selected, this screen will be displayed indefinitely, or until battery power has been depleted.

## 10 FOOTSWITCH

This feature allows the indicator to execute up to three functions in sequence, separated by an optional delay, when the External Trigger input (pin 14 on the I/O connector) transitions from a high level to a low level, or from a low level to a high level. The ET input has an internal pull-up resistor. One suggested method for triggering the footswitch sequence would be to provide a relay or contact closure to ground.

To enable the footswitch settings, select **Footswitch** from the menu. The display appears as follows:

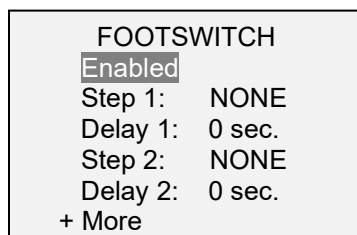

Select "+ More" for additional options:

FOOTSWITCH 2

Step 3: NONE  
\* Active Low (NO)  
Active High (NC)

Function	Description
<b>Enabled</b>	Press <b>ENTER</b> to enable, and an asterisk appears.
<b>Step 1 / 2 / 3</b>	Set the desired command. Available commands: <i>?, ?C, ?PT, ?PC, ?A, Z, CLR, PM, DATA Key, and NONE.</i> <i>DATA Key</i> simulates a press of the <b>DATA</b> key. Explanations for other commands may be found in the <b>Communications and Outputs</b> section.
<b>Delay 1 / 2 / 3</b>	Set the desired delay between commands. Available settings: <i>0 – 5 sec. in 1 sec. increments, and 5 – 60 in 5 sec. increments.</i>
<b>Active Low (NO)</b>	Normally open contact between pin and ground.
<b>Active High (NC)</b>	Normally closed contact between pin and ground.

## 11 COEFFICIENT OF FRICTION

Series 7 gauges can determine the static and kinetic coefficients of friction (COF) between two materials through the Averaging and peak tension capture functions. The process for determining COF requires dragging a block of a known mass (usually 200 g) over a surface at a constant speed. The force required to do so is divided by the weight of the block. For example, a force of 100 gF divided by 200 g equals 0.5 COF.

Although many COF testing applications require a sled weight of 200 g, the gauge allows the user to change the sled weight to comply with other requirements. To modify the sled weight, select **COF** from the menu. The display appears as follows:

COF

**Enabled**

Sled Weight Unit  
g  
Sled Weight  
200.0

Available sled weight settings: *10% to 100% of the gauge capacity*

Motorized test stands and suitable fixtures are recommended for COF measurement applications.

**Recommended products:** ESM303 test stand, and G1086 COF fixture

## 12 CUSTOM UNIT

A user-defined unit of measurement may be configured for special applications. A base unit is specified, along with a multiplier, and 5-character name. Typical applications:

1. To measure the torque produced by pressing on a lever in a mechanical assembly, configure the multiplier based on the length of the lever, thereby converting a unit such as N into Ncm.
2. To measure the pressure produced by a circular compression plate on a foam sample, configure the multiplier based on the area of the plate, thereby converting a unit such as lbF into psi.

To access this feature, select **Custom Unit** from the menu. The display appears as follows:

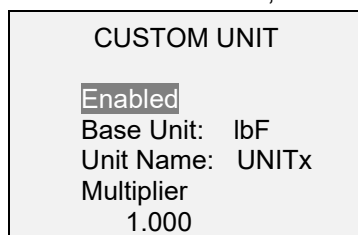

Function	Description
<b>Enabled</b>	Press <b>ENTER</b> to enable and an asterisk appears. After exiting the menu, the custom unit appears as one of the available units.
<b>Base Unit</b>	Select any available standard unit.
<b>Unit Name</b>	Specify up to 5 alphanumeric characters, using the <b>▶</b> key to advance to the next character, and the <b>▲</b> and <b>▼</b> keys to scroll through the available characters. The character “_” refers to a space. <b>Note:</b> Unit names with the same abbreviations as other standard units are not allowed. If a disallowed name is entered, a warning message will appear.
<b>Multiplier</b>	Select a value relative to the base unit. Available values: 0.001 – 1,000 <b>Note:</b> Lowest value must correspond to a resolution of at least 0.00001. Highest value must correspond to a maximum displayed reading of 500,000.

## 13 COMMUNICATIONS AND OUTPUTS

Communication with Series 7 force gauges is achieved through the micro USB or 15-pin serial ports located at the bottom of the instrument, as shown in the illustration in the **Power** section. Communication is possible only when the gauge is in the main operating screen (i.e. not in a menu or configuration area).

### 13.1 Serial / USB

To set up RS-232 and USB communication, select **Serial/USB Settings** from the menu. The screen appears as follows:

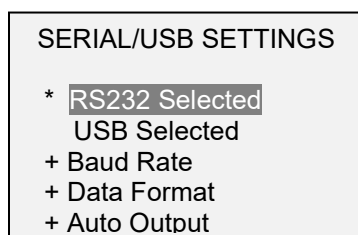



Select either RS-232 or USB input (output is always active for both the USB and RS-232 ports). RS-232 must be selected when communicating through a Mark-10 test stand controller. When communicating from the gauge directly to a PC or data collector, either RS-232 or USB can be selected as required. Press **DATA** to transmit individual data points or to commence an automatic output sequence (see **Automatic Output** sub-section for details). Single point or continuous data may also be requested via ASCII commands from an external device (see **Command Set** sub-section for details).

Communication settings are permanently set to the following:

**Data Bits:** 8  
**Stop Bits:** 1  
**Parity:** None

Other settings are configured as follows:

#### 13.1.1 Baud Rate

Select the baud rate as required for the application. It must be set to the same value as the receiving device. When communicating with a Mark-10 test stand controller, the baud rate must be set to 115,200.

#### 13.1.2 Data Format

Select the desired data format. The screen appears as follows:

DATA FORMAT

\* **Numeric + Units**  
 Numeric Only  
 Invert Polarity  
 Omit Polarity

Selection	Description
<b>Numeric + Units</b>	Output format includes the value and unit of measure. Compression values have positive polarity, tension values have negative polarity.
<b>Numeric Only</b>	Output format includes the value only. Polarity same as above.
<b>Invert Polarity</b>	Compression values have negative polarity, tension values have positive polarity. May be selected in addition to the Numeric + Units / Numeric Only selection.
<b>Omit Polarity</b>	Both directions are formatted with positive polarity. May be selected in addition to the Numeric + Units / Numeric Only selection.

#### 13.1.3 Automatic Output

The gauge has the ability to output data continuously via RS-232 or USB. To enable automatic output, select **Auto Output** from the **Serial/USB Settings** sub-menu. The screen appears as follows:

AUTO OUTPUT

\* **Disabled**  
 Enabled  
 Readings / sec.  
 10

Select **Enabled** to activate automatic output. The number of readings per second can be set to 1, 2, 5, 10, 25, 50, 125, or 250. The capabilities of the receiving device should be considered when selecting the data output rate.

After the settings have been saved, revert to the home screen. An icon appears in the lower left corner of the display, as follows: **■■■■** This indicates that automatic data output has been armed. Automatic output of data may be initiated by pressing **DATA** or by sending the appropriate ASCII command from an external device (see **Command Set** sub-section for details). The icon will become animated, signaling that automatic output is occurring. Press **DATA** again to end the data transmission.

### 13.2 Mitutoyo BCD settings

This output is useful for connection to data collectors, printers, multiplexers, or any other device capable of accepting Mitutoyo BCD data. Individual data points may be transmitted by pressing **DATA** or by requesting it from the Mitutoyo communication device (if available). To enable Mitutoyo output, select the desired format – either with polarity or without polarity. The screen appears as follows:



### 13.3 Analog Output

This output can be used for chart recorders, oscilloscopes, data acquisition systems, or any other compatible devices with analog inputs. The output produces  $\pm 1$  volt at full scale of the instrument. The polarity of the signal is positive for compression and negative for tension.

### 13.4 DATA Key Functions

The **DATA** key can be configured to perform several functions. To configure the **DATA** key, select **DATA Key** from the menu. The display appears as follows:

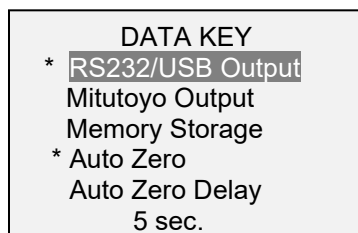

Selection	Function when pressing DATA
<b>RS232/USB Output</b>	Outputs data via the serial and USB ports
<b>Mitutoyo Output</b>	Outputs data via Mitutoyo (Digimatic)
<b>Memory Storage</b>	Stores a reading to memory (refer to the <b>Memory</b> section for details)
<b>Auto Zero</b>	Automatically zero the reading as if the <b>ZERO</b> key has been pressed after the reading is output and/or it is stored in memory.
<b>Auto Zero Delay</b>	The amount of time before the auto-zero occurs, in seconds: 1 – 10 seconds in 1 second increments, and 10 – 60 seconds in 5 second increments.

Any combination of the above functions may be selected.

## 13.5 I/O Connector Pin Diagram (DB-9HD-15 female)

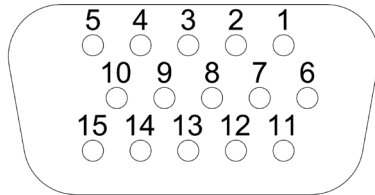

Pin No.	Description	Input / Output
1	Signal Ground	---
2 *	Tension Overload *	Output *
3	RS-232 Receive	Input
4	RS-232 Transmit	Output
5	+12V DC	Input / Output
6	Analog Output	Output
7 *	Compression Overload *	Output *
8	Mitutoyo Clock or Output Bit 2 (mutually exclusive)	Output
9	Mitutoyo Data or Output Bit 0 (mutually exclusive)	Output
10	Mitutoyo Request or Input Bit 3 (mutually exclusive)	Input
11 **	Set Point Pin 1 (SP1)**	Output **
12 **	Set Point Pin 2 (SP2)**	Output **
13 **	Set Point Pin 3 (SP3)**	Output **
14	External Trigger or Footswitch (mutually exclusive)	Input
15 *	Mitutoyo Ready or Output Bit 1 (mutually exclusive) *	Output *

\* Maximum voltage: 40V.

\*\* The output assignments depend on several factors described in the table below. Output functions always reference the primary reading on the display, regardless of the current mode.

Force	Pin 11 (SP1)	Pin 12 (SP2)	Pin 13 (SP3)
<b>Upper and Lower Set Points are Compression</b>			
Greater than or equal to upper set point	On	Off	Off
Between upper and lower set points	Off	Off	On
Less than or equal to lower set point	Off	On	Off
<b>Upper and Lower Set Points are Tension</b>			
Greater than or equal to upper set point	Off	On	Off
Between upper and lower set points	Off	Off	On
Less than or equal to lower set point	On	Off	Off
<b>Upper Set Point is Compression, Lower Set Point is Tension</b>			
Greater than or equal to upper set point, in compression	Off	On	Off
Between upper and lower set points	Off	Off	On
Greater than or equal to lower set point, in tension	On	Off	Off
<b>Upper Set Point is Tension, Lower Set Point is Compression</b>			
Greater than or equal to upper set point, in tension	Off	On	Off
Between upper and lower set points	Off	Off	On
Greater than or equal to lower set point, in compression	On	Off	Off

### 13.6 Command Set / Gauge Control Language 2 (GCL2)

Series 7 force gauges may be controlled by an external device through the RS-232 or USB channels. The following is a list of supported commands and their explanations. All commands must be terminated by a CR (Carriage Return) character, 0x0D, or a CR-LF (Carriage Return – Line Feed) pair, where the Line Feed, 0x0A, is ignored.

#### Request Readings

?	Request the displayed reading (dependent on operating mode)
?C	Request the current (real time) reading
?PT	Request the peak tension reading (corresponds to static COF)
?PC	Request the peak compression reading
?ET	Request the reading obtained during the External trigger mode
?A	Request the average reading obtained during the Average mode (corresponds to kinetic COF)
?P1	Request 1 <sup>st</sup> peak reading

#### Units

LB	Switch units to pound-force
OZ	Switch units to ounce-force
KG	Switch units to kilogram-force
G	Switch units to gram-force
N	Switch units to Newtons
MN	Switch units to Milli-Newtons
KN	Switch units to Kilo-Newtons
COF	Switch units to Coefficient of Friction
CU	Switch to user-defined custom unit
COFE	Enable Coefficient of Friction unit
COFD	Disable Coefficient of Friction unit
CUE	Enable user-defined custom unit
CUD	Disable user-defined custom unit

#### Basic Functions

CUR	Select Current (real time) mode
PT	Select Peak Tension mode
PC	Select Peak Compression mode
FSPK	Select First / Second Peak mode (must first be enabled in the menu)
CAPT	Select Data Capture mode (must first be enabled in the menu)
CLR	Clear peaks
Z	Zero display and perform the CLR function

#### Filters

FLTPn	Digital filter for displayed readings
FLTCn	Digital filter for current readings n= 0-10, filter = 2 <sup>n</sup> , ex: n=0= no filter, n=10=1024 samples averaged

#### Memory & Statistics

MEM	Transmit all stored readings
STA	Transmit statistics
CLRMEM	Delete all stored readings from memory

#### Set Points

SPHD	Disable high set point
SPLD	Disable low set point
SPHn	High set point. n=value (+ for compression, - for tension)
SPLn	Low set point. n=value (+ for compression, - for tension)

**USB/RS-232 Communication**

FULL	USB/RS-232 transmission with units
NUM	USB/RS-232 transmission without units (only numeric values)
AOUTn	Auto-transmit n times per second n=1, 2, 5, 10, 25, 50, 125, 250. 0=disabled <b>Note:</b> n = 1 = yields 50 times per second. This is provided for backward compatibility with legacy gauges.
IPOLn	Invert polarity of output. n=1=invert polarity. n=0=normal (default) <b>Note:</b> Normal polarity is positive for compression and negative for tension.
OPOLn	Omit polarity of output. n=1=omit polarity. n=0=include polarity (default) <b>Note:</b> The "+" sign is always omitted. A "-" sign is sent when polarity is enabled.

**Mitutoyo Communication**

MIT	Enable Mitutoyo output
MITD	Disable Mitutoyo output
POL	Mitutoyo output with polarity (+ for compression, - for tension)
NPOL	Mitutoyo output without polarity (absolute value)
PM	Print/send data to a Mitutoyo-compatible device

**Averaging**

A	Enable Average mode
AD	Disable Average mode
AM	Select Average mode (if enabled) for primary reading
TRFn	Trigger force. n=value (+ for compression, - for tension)
DELn	Initial delay. n=0.1-300.0 seconds
ATn	Average time. n=0.1-300.0 seconds

**External Trigger**

ETH	Enable high level-triggered External trigger mode
ETL	Enable low level-triggered External trigger mode
ETHL	Enable reading captured on a high to low transition
ETLH	Enable reading captured on a low to high transition
ETD	Disable External trigger mode

**Input / Output Bits**

Sn	Set output bit (open drain, pull to ground). n=0, 1, 2
Cn	Clear output bit. n=0, 1, 2
Rn	Read current status of output bit or level of input pin. n=0, 1, 2, 3

**Personality**

RN	Read product name
RM	Read model number
RV	Read firmware version number
RS	Read serial number

**Other Commands**

AOFFn	Auto-shutoff. n=0-30 minutes. 0=auto shutoff disabled
SAVE	Save current settings in nonvolatile memory
LIST	List current settings and status

**13.7 Command Responses**

In response to a reading request command (those which begin with '?') the gauge will return a string with the load data, followed by a space, then the load unit (if enabled under the **Serial/USB Settings** → **Data format** sub-menu). It will be terminated by a CR-LF pair.

Example return strings:

```
-0.486 lbF<CR><LF>    0.486 lbF of tension force
1.724 N<CR><LF>      1.724 N of compression force
```

The number of digits after the decimal point is dependent of the instrument's capacity and resolution.

By default, the minus sign (-) indicates tension, and the absence of a sign indicates compression. However, positive / negative polarity may be inverted or omitted under the **Serial/USB Settings → Data Format** sub-menu.

Following is an example LIST output:

```
V1.00;LBF;CUR;FLTC8;FLTP1;AOUT00;AOFF5;FULL;IPOL0;OPOL0;MIT;POL;B0
```

All fields are separated by “;”. The first field shows the firmware version, the last field shows the remaining battery power (B0=full charge, B3=minimum power). All other fields show the status of settings and features using the same abbreviations as the commands to set them.

Any detected errors are reported back by means of the following error codes:

- \*10 Illegal command
- \*11 Not applicable
- \*21 Invalid specifier
- \*22 Value too large
- \*51 Command string too long (25 characters maximum)

## 14 CALIBRATION

---

### 14.1 Initial Physical Setup

The gauge should be mounted vertically to a test stand or fixture rugged enough to withstand a load equal to the full capacity of the instrument. Certified deadweights or master load cells should be used, along with appropriate mounting brackets and fixtures. Caution should be taken while handling such equipment.

### 14.2 Calibration Procedure

1. Select **Calibration** from the menu. The display appears as follows:

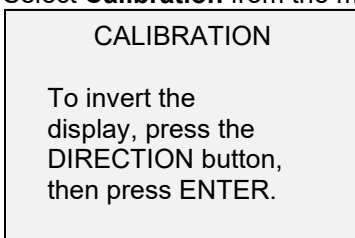

2. Press **DIRECTION** to invert the display, if desired. **ENTER** to continue. The display appears as follows:

CALIBRATION  
Enter # cal points  
(1 to 10)  
Compression:  
5  
Tension:  
5

The gauge can be calibrated at up to 10 points in each direction. Enter the number of calibration points for each direction (compression and tension). At least one point must be selected for each direction.

**Note:** To achieve the accuracy specification of  $\pm 0.1\%$ , it is recommended to calibrate the gauge at 5 or more even increments in both tension and compression directions. For example, a gauge with capacity of 10 lbf should be calibrated at 2, 4, 6, 8, and 10 lb loads in each direction.

3. To escape the **Calibration** menu at any time, press **ESCAPE**. The display appears as follows:

CALIBRATION  
NOT COMPLETE  
  
Cancel  
Exit w/o saving

Selecting "Cancel" will revert back to the Calibration setup. Selecting "Exit w/o saving" will return to the menu without saving changes.

4. After the number of calibration points has been entered, press **ENTER**. The display appears as follows:

CALIBRATION  
OFFSET  
  
Place force gauge  
horizontally, then  
press ZERO.

5. Place the force gauge horizontally on a level surface free from vibration, then press **ZERO**. The gauge will calculate internal offsets, and the display appears as follows:

CALIBRATION  
OFFSET  
  
Please wait...

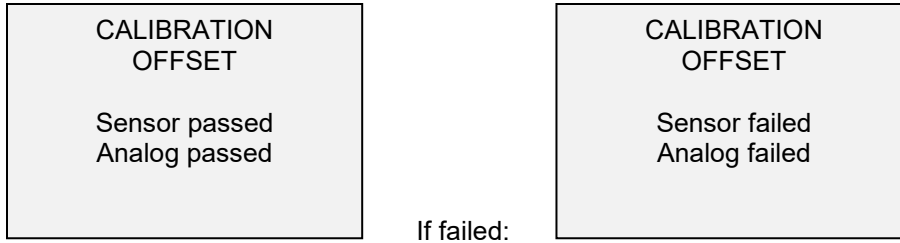

6. The following screen appears after the offsets have been calculated:



Attach weight fixtures (brackets, hooks, etc), as required. Do not yet attach any weights or apply any calibration loads. Press **ENTER**.

7. The display appears as follows:

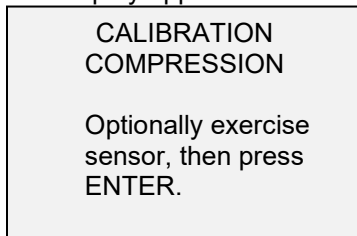

Optionally exercise the load cell shaft several times (at full scale, if possible), then press **ENTER**.

8. The display appears as follows:



Apply a weight equal to the full scale of the instrument, then press **ENTER**.

9. After displaying "Please wait..." the display appears as follows:

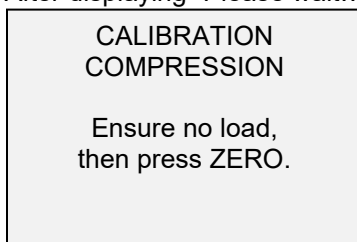

Remove the load applied in Step 8, leave the fixtures in place, then press **ZERO**.



10. The display appears as follows:

```
CALIBRATION
COMPRESSION
Apply load
1 OF 5
Enter load:
2.000 lbF
Press ENTER.
```

Use the **UP** and **DOWN** keys to adjust the load value as required. The load values default to even increments, as indicated by the previously entered number of data points (even increments are recommended for best results). For example, if a 50 lbF capacity gauge is calibrated, and 5 data points were selected, the load values will default to 10, 20, 30, 40, and 50 lb. Apply the calibration load. Then press **ENTER**.

Repeat the above step for the number of data points selected.

11. After all the compression calibration points have been completed, the display appears as follows:

```
CALIBRATION
COMPRESSION COMPLETE
Reverse direction
for tension.
Attach necessary
weight fixtures,
then press ENTER.
```

Press **ENTER**.

12. The display appears as follows:

```
CALIBRATION

To invert the
display, press the
DIRECTION button,
then press ENTER
```

Reverse the orientation of the load cell shaft by rotating the gauge 180 degrees. Press **DIRECTION** to invert the display. Then attach weight fixtures. The following screens will step through the same procedure as with the compression direction. Proceed in the same manner.

13. At the completion of the tension calibration, the display appears as follows:

```
CALIBRATION
COMPLETE

Save & exit
Exit w/o saving
```

To save the calibration information, select "Save & exit". To exit without saving the data select "Exit without saving".

14. Any errors are reported by the following screens:

CALIBRATION  
Units must be gF.  
Please try again  
Press ENTER.

Displayed at the start of calibration if a disallowed unit is selected.

CALIBRATION  
Load not stable.  
Please try again.

Ensure that the load is not swinging, oscillating, or vibrating in any manner. Then try again.

CALIBRATION  
COMPRESSION  
Load too low.  
Please try again.

The calibration weight does not match the set value.

CALIBRATION  
TENSION  
Load too close  
to previous.  
Please try again.

The entered calibration point is too close to the previous point.

## 15 PASSWORDS

Two separate passwords may be set to control access to the Calibration section and to the menu and other keys. To access the passwords setup screen, select **Passwords** from the menu. The display appears as follows:

PASSWORDS  
Calibration  
MENU Key  
UNITS Key  
MODE Key  
ZERO Key  
+ More

Select "+ More" for additional options:

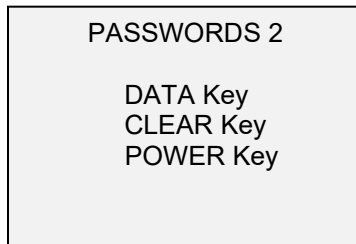

### 15.1 Calibration Password

Select **Calibration** from the sub-menu. The display appears as follows:



To set the password, select **Enabled**, then **Set Password**. Use the **UP** and **DOWN** keys to increment and decrement the value, from 0 to 9999. When the desired value has been selected, press **ENTER**, then **ESC** to exit the sub-menu.

### 15.2 MENU Key Password

If enabled, every time the **MENU** key is selected, a password must be provided. Select **Menu Key** from the sub-menu. Follow the same procedure as described above.

### 15.3 Locking Out Other Keys

Other keys may be locked out individually. Select any combination of keys (**UNITS**, **MODE**, **ZERO**, **DATA**) by pressing **ENTER** in the **Passwords** sub-menu. Pressing a locked key will prompt the message "KEY PROTECTED" and then revert to the previous screen.

### 15.4 Password Prompts

If passwords have been enabled, the following will be displayed when pressing the **MENU** key or accessing the **Calibration** section:

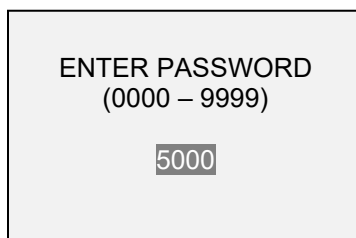

Use the **UP** and **DOWN** keys to select the correct password, then press **ENTER** to continue.

If the incorrect password has been entered, the display appears as follows:

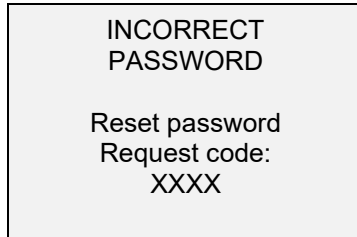

To re-enter the password, press **ESC** to exit to the home screen. Then, access the desired function and enter the password again when prompted.

If the password has been misplaced, it can be reset. Press **ENTER** to generate a *request code*. The *request code* must be supplied to Mark-10 or a distributor, who will then provide a corresponding *authorization code*. Enter the *activation code* to disable the password.

## 16 OTHER SETTINGS

### 16.1 Automatic Shutoff

The gauge may be configured to automatically power off following a period of inactivity while on battery power. Inactivity is defined as the absence of any key presses or load changes of 100 counts or less. To access these settings, select **Automatic Shutoff** from the menu. The display appears as follows:



Selection	Description
<b>Disabled</b>	Disable automatic shutoff.
<b>Enabled</b>	Enable automatic shutoff.
<b>Set Minutes</b>	The length of time of inactivity. Available settings: 5-30, in 5 minute increments.

**Note:** If the AC adapter is plugged in, the gauge will ignore these settings and remain powered on until the **POWER** key is pressed.

### 16.2 Backlight

Although the backlight may be turned on and off at any time by pressing the **BACKLIGHT** key, there are several available initial settings (applicable upon powering on the gauge). To access these settings, select **Backlight** from the menu. The display appears as follows:



Selection	Description
<b>Off</b>	Backlight to be off upon powering on the gauge.
<b>On</b>	Backlight to be on upon powering on the gauge.
<b>Auto</b>	Backlight to be on upon powering gauge, but will shut off after a period of inactivity (as defined in the <b>Automatic Shutoff</b> sub-section). The backlight will turn on again when activity resumes. The length of time of inactivity is programmed in minutes via the <b>Set Minutes</b> parameter. Available settings: 1-10, in 1 minute increments.

**Note:** If the AC adapter is plugged in, the gauge will ignore these settings and keep the backlight on.

### 16.3 LCD Contrast

The contrast of the display may be adjusted. Select **LCD Contrast** from the menu. The screen appears as follows:



Press **ENTER** to modify the contrast. Select a value from 0 to 25, 25 producing the most contrast.

### 16.4 Tones

Audible tones can be enabled for all key presses and alerts, such as overload, set point value reached, etc. The Set Point alert can be configured to be either a momentary tone or a continuous tone (until the load is restored to a value between the set points). To configure the functions for which audible tones will apply, select **Tones** from the menu. The screen appears as follows:

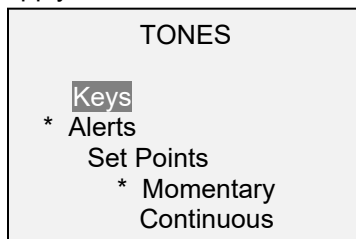

### 16.5 Initial settings

This section is used to configure the initial settings upon powering on the gauge. The initial units of measurement and the primary reading measurement mode may be configured. To access these settings, select **Initial Settings** from the menu. The screen appears as follows:

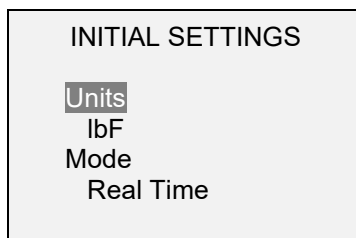

### 16.6 Restore Default Settings

Default factory settings can be restored by selecting **Restore Defaults** from the menu. The settings may be found in the **Specifications** section. The screen appears as follows:

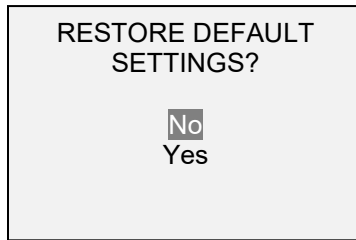

### 16.7 Information / Welcome Screen

The following screen is displayed at power-up and can be accessed at any time by selecting **Information** from the menu:

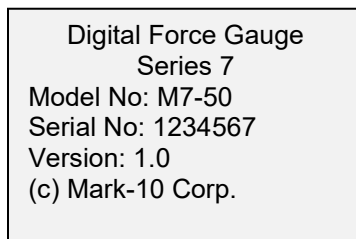

## 17 SPECIFICATIONS

### 17.1 General

<b>Accuracy:</b>	±0.1% of full scale
<b>Sampling rate:</b>	14,000 Hz
<b>Power:</b>	AC adapter: 100-240VAC, 50-60 Hz, 0.3 A Battery: Rechargeable 8.4V NiMH Low battery indicator appears when battery level is low, and gauge powers off automatically when power reaches critical stage.
<b>Battery life:</b>	<b>Backlight on:</b> up to 7 hours of continuous use <b>Backlight off:</b> up to 24 hours of continuous use
<b>Measurement units:</b>	lbF, ozF, gF, kgF, N, kN, mN, COF (depending on model)
<b>Outputs:</b>	<b>USB / RS-232:</b> Fully configurable up to 115,200 baud. Includes GCL2 (Gauge Control Language 2) for full computer control. <b>Mitutoyo (Digimatic):</b> Serial BCD suitable for all Mitutoyo SPC-compatible devices. <b>Analog:</b> ±1 VDC, ±0.25% of full scale at capacity, <b>General purpose:</b> Three open drain outputs, one input. <b>Set points:</b> Three open drain lines.
<b>Safe overload:</b>	200% of full scale (display shows "OVER" at 110% and above)
<b>Weight (gauge only):</b>	<b>M7-012 – M7-100:</b> 1.0 lb [0.45 kg] <b>M7-200 – M7-500:</b> 1.2 lb [0.54 kg]
<b>Included accessories:</b>	Carrying case, chisel, cone, V-groove, hook, flat, extension rod, thread adapter (M5-1000 only), AC adapter, battery, USB cable, NIST-traceable certificate of calibration with data
<b>Environmental requirements:</b>	Indoor use only, at 40 - 100°F, max. 93% humidity, non-condensing.
<b>Warranty:</b>	3 years (see individual statement for further details)

## 17.2 Factory Default Settings

Parameter	Setting
Set points	
Upper	Disabled (defaults to 80% of full scale, compression, when enabled)
Lower	Disabled (defaults to 40% of full scale, compression, when enabled)
Filters	
Current	16
Displayed	2048
Average mode	Disabled
Initial Delay	0
Trigger Force	10% of full scale
Averaging Time (sec.)	5.0
Auto Output Settings	All disabled
Auto Zero Delay	5 sec.
External Trigger	Disabled
Auto Output Settings	All disabled
Auto Zero Delay	5 sec.
DATA Key Functions	
RS-232/USB Output	Enabled
Mitutoyo Output	Disabled
Memory Storage	Enabled
Auto Zero	Disabled
Auto Zero Delay	5 sec.
Serial/USB	
RS-232 Output Selected	Enabled
USB Output Selected	Disabled
Baud Rate	115,200
Data Format	Numeric + Units
Auto Output	Disabled
Outputs per Sec.	125
Mitutoyo BCD Output	Disabled
Break Detection	Disabled
Threshold	10% of full scale
% Drop	50% of peak
Auto Zero Delay	5 sec.
Auto Output Settings	All disabled
Auto Storage	Disabled
Auto Zero	Disabled
First, Second Peak	Disabled
Thresholds	10%
% Drops	50%
Auto Zero Delay	5 sec.
Auto Output Settings	All disabled
Auto Store Peaks	Disabled
Data Capture	Disabled
Period	00:00:01:00000
Start Condition	Start force of 10% of full scale
Stop Condition	Stop force of 20% of full scale
Auto Settings	All disabled
Footswitch	Disabled
Steps 1 / 2 / 3	None
Delays 1 / 2 / 3	0 sec.
COF	Disabled
Sled Weight	20% of full scale
Custom Unit	Disabled
Base Unit	lbf
Multiplier	1.000
Tones	

Keys	Enabled
Alerts	Enabled
Set Points	Momentary
Automatic Shutoff	Enabled
Set Minutes	5
Backlight	Auto
Set Minutes	1
Initial Settings	
Units	lbF
Mode	Real Time
Passwords	All disabled

### 17.3 Capacity x Resolution

Model	lbF	ozF	kgF	gF	N	kN	mN
<b>M7-012</b>	0.12 x 0.00002	2 x 0.0005	-	50 x 0.01	0.5 x 0.0001	-	500 x 0.1
<b>M7-025</b>	0.25 x 0.00005	4 x 0.001	-	100 x 0.02	1 x 0.0002	-	1000 x 0.2
<b>M7-05</b>	0.5 x 0.0001	8 x 0.002	-	250 x 0.05	2.5 x 0.0005	-	2500 x 0.5
<b>M7-2</b>	2 x 0.0005	32 x 0.01	1 x 0.0002	1000 x 0.2	10 x 0.002	-	-
<b>M7-5</b>	5 x 0.001	80 x 0.02	2.5 x 0.0005	2500 x 0.5	25 x 0.005	-	-
<b>M7-10</b>	10 x 0.002	160 x 0.05	5 x 0.001	5000 x 1	50 x 0.01	-	-
<b>M7-20</b>	20 x 0.005	320 x 0.1	10 x 0.002	10000 x 2	100 x 0.02	-	-
<b>M7-50</b>	50 x 0.01	800 x 0.2	25 x 0.005	25000 x 5	250 x 0.05	-	-
<b>M7-100</b>	100 x 0.02	1600 x 0.5	50 x 0.01	50000 x 10	500 x 0.1	-	-
<b>M7-200</b>	200 x 0.05	3200 x 1	100 x 0.02	-	1000 x 0.2	1 x 0.0002	-
<b>M7-500</b>	500 x 0.1	8000 x 2	250 x 0.05	-	2500 x 0.5	2.5 x 0.0005	-

COF and user-defined units are excluded from the above chart.

### 17.4 Load Cell Deflection

Model	Deflection (in [mm])
<b>M7-012</b>	0.005 [0.13]
<b>M7-025 – M7-500</b>	0.010 [0.25]



17.5 Dimensions  
IN [MM]

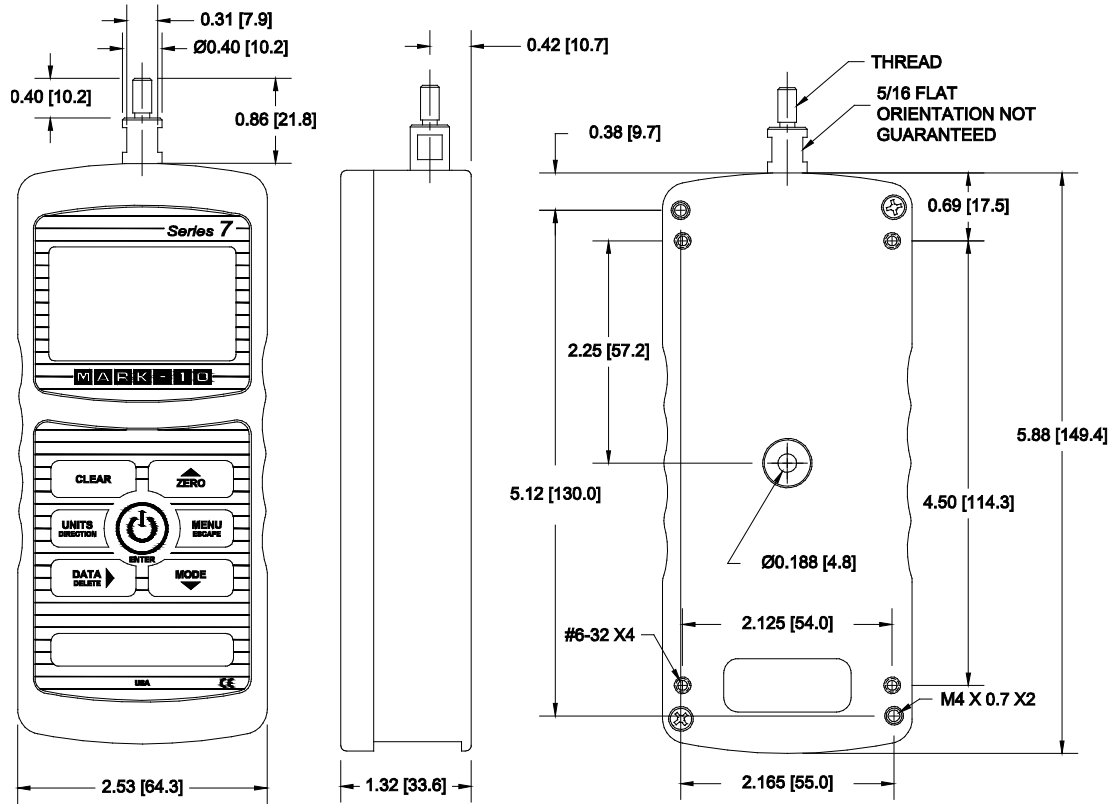

	Thread	Flat
M7-012 – M7-100	#10-32M UNF	5/16 [7.94]
M7-200 – M7-500	5/16-18M UNC	5/16 [7.94]