

## 2 YEAR WARRANTY (RESTRICTIONS APPLY)

Imada, Inc. warrants its products to the original purchaser to be free from defects in workmanship and material under normal use and proper maintenance for two years (one year for adapters, attachments and cables) from original purchase. This warranty shall not be effective if the product has been subject to overload, shock load, misuse, negligence, accident or repairs attempted by others than Imada, Inc.

During the warranty period, we will, at our option, either repair or replace defective products. Please call our customer service department for a return authorization number and return the defective product to us with freight prepaid.

The foregoing warranty constitutes the SOLE AND EXCLUSIVE WARRANTY, and we hereby disclaim all other warranties, express, statutory or implied, applicable to the products and/or software, including but not limited to all implied warranties of merchantability, fitness, non-infringement, results, accuracy, security and freedom from computer virus. In no event shall Imada, Inc. and/or its affiliated companies be liable for any incidental, consequential or punitive damages in connection with the use of its products and/or software.

# Digital Force Gauge

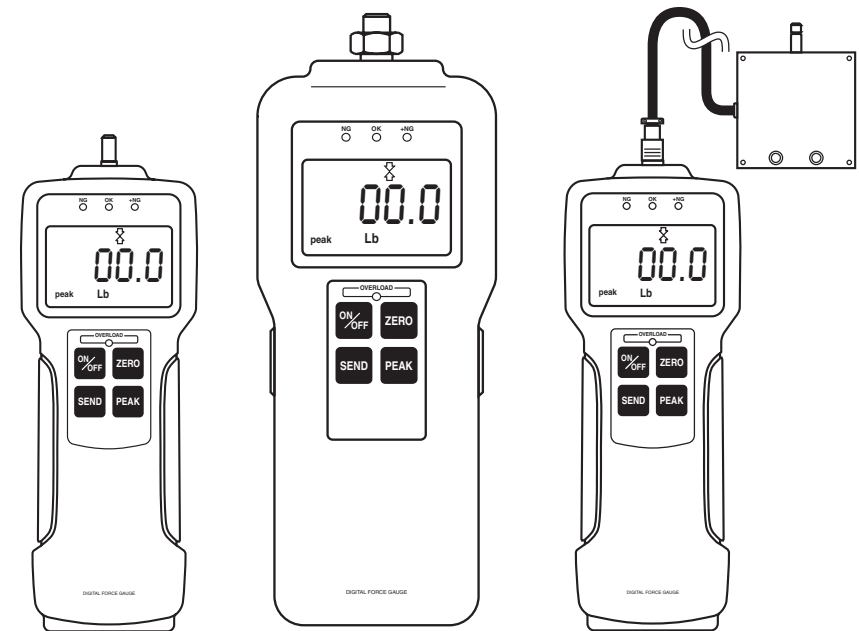

## Z Series

USB Models: ZP, ZPH and ZPS



Albuquerque Industrial  
69-10 108th Street # 2-O  
Forest Hills, NY 11375 U.S.A.

www.abqindustrial.net  
e-mail: info@abqindustrial.net  
Toll Free: +1 (888) 275-5772  
Tel: +1 (718) 846-6458  
Fax: +1 (718) 846-6459

## INTRODUCTION

Imada Z Series are state-of-the-art high performance, digital force gauges which offer USB output, giant, easy-to-read LCD displays and high/low setpoints with color-coded LED indicators for go/no go testing. These force gauges store up to 1,000 data values in memory, which can be transmitted using USB or RS-232 or output formats.

The real time measuring mode is used to display force transients. Peak measuring mode captures the peak force achieved during a test. Select measuring units from lbf(ozf), kgf(gf), and N.

## IMPORTANT

1. **WARNING!!** Test samples and fixtures can break or shatter, wear eye and body protection to avoid injury.
2. **WARNING!!** REGARDLESS of whether the unit is ON or OFF, **DO NOT** exceed the capacity of the gauge. At 110% of the rated capacity, the overload LED indicator flashes to warn. NEVER exceed 200% of the rated capacity, or the load cell will be damaged. Avoid shock load.
3. When mounting Z Series, use M4 mounting screws with a maximum insertion depth of 5 mm into the gauge. For high capacity gauges (ZPH) use mounting hardware supplied only.
4. Measure in line tension and compression forces only. **DO NOT** attempt to measure forces perpendicular to the measuring shaft – damage to load cell and/or shaft may result.
5. Hand tighten attachments only. **DO NOT** use tools.
6. Make sure this gauge and all peripherals are powered down before attaching any cables.
7. **DO NOT** disassemble the gauge. Disassembly voids warranty.

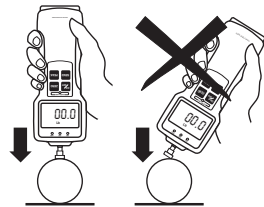

**Save As...** – ① modify file path and file name. *Choose File* → *Folder and file name setup* or press the save button and select *Save the data to new.csv file*.

**Clear Memory** – ② all data in force gauge memory cleared. *Choose Option* → *Erase all of memory*

**Top Most** – ② ZP Logger is locked in the foreground; uncheck to run ZP Logger in the background. *Choose Option* → *TopMost*

**Track/Peak Indicator** – ③ Displays peak or real time measuring mode. Press Peak key on gauge to select desired mode.

**Online/Offline Indicator** – ④ Online is displayed when the force gauge is interfaced to the computer through the USB port.

**Zero Button** – ⑤ Press Zero on ZP Logger or gauge to tare the weight of the attachment and shaft orientation. Zero also clears peak reading.

**Read Current Val. Button** – ⑥ Equivalent to pressing the Send key on the gauge.

**Read Memorized Button** – ⑦ Download and log all data from gauge memory.

**Clear Button** – ⑧ completely clear ZP Logger data pad.

**Copy Button** – ⑨ copy ZP Logger data to the clipboard.

**Save Button** – ⑩ Press Zero on ZP Logger or gauge to tare the weight of the attachment and shaft orientation. Zero also clears peak reading. From the list:

1. Select *Save the data to new csv file* to save a new CSV file to the name and path specified.
2. Select *Save the data to new row of existing csv file* to modify an existing CSV file by adding a new column of data. File modified must agree with ZP Logger CSV format.
3. Select *Folder and file name set up* to modify the file path and file name.

## ZP Logger Operation

1. Click Start/Programs/Imada/ZP Logger
2. Turn on the gauge and confirm the USB caption is visible on the gauge display.
3. Connect the ZP, ZPH or ZPS force gauge to the computer with the USB cable provided.
4. Turn on the gauge. The ZP Logger Online/Offline indicator should change to Online (blue).

If Indicator doesn't change to Online, check:

USB cable

USB driver installation

Microsoft.NET Framework 1.1 installation.

If **ZP Recorder** software (optional) is running, it should be closed.

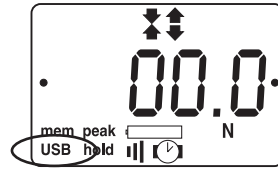

### Download Gauge Memory – ⑦

On startup of ZP Logger press the Read Memorized button to download and log gauge memory to ZP Logger. This feature is disabled if Read Current Val button or the Send key on gauge are pressed or enabled if the Clear key is pressed. Data can then be saved by using the File menu or Save button.

### Record Gauge Data – ⑥

Press the Send key on the gauge or the Read Current Val button on the ZP Logger. Peak or real time data goes into internal gauge memory as well as ZP Logger.

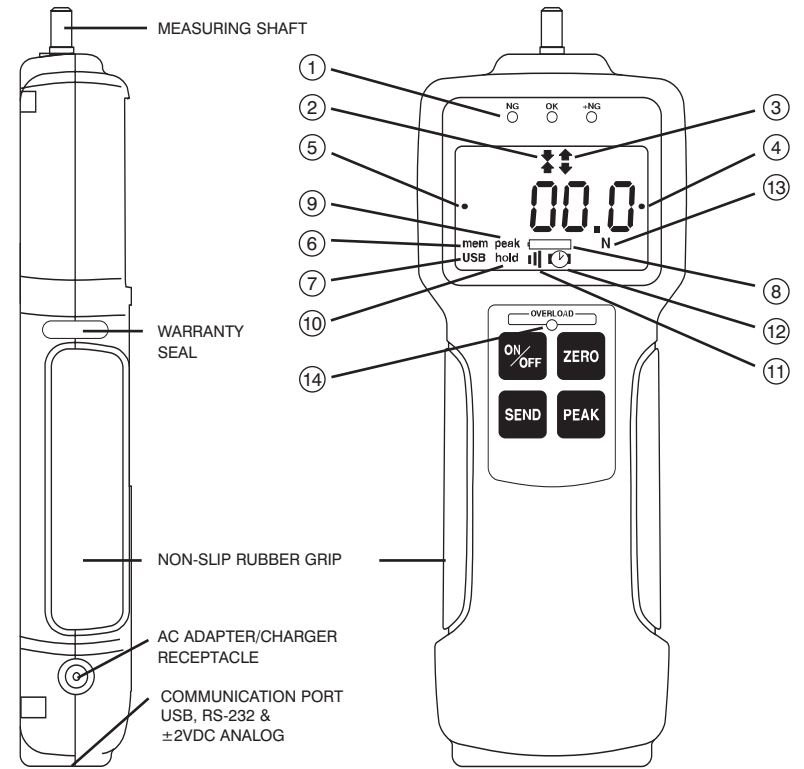
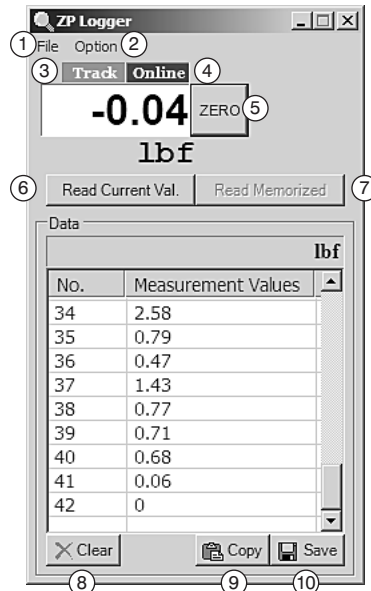

ZP, ZPH, and ZPS (with remote sensor) use the same keypad.

- ① **Programmable Setpoint LED's**  
When high-low setpoints are set, LED indicates below (-NG), within (OK), or above set point value (+NG).
- ② **Compression icon**  
Indicates compression measurement.
- ③ **Tension icon**  
Indicates tension measurement.
- ④ **Reverse +/- values**
- ⑤ **Auto Zero Reset icon**  
Programmable auto zero reset duration
- ⑥ **Auto Memory - Peak Reset icon**
- ⑦ **USB output icon**
- ⑧ **Battery icon**  
Flashes when Ni-MH cells need charging.
- ⑨ **PEAK icon**  
Displays continuously when peak function is active.
- ⑩ **HOLD icon**  
Displays when external hold signal is active or SEND button is pressed.
- ⑪ **Alarm Icon**
- ⑫ **Auto Power Off icon**
- ⑬ **Units icon**  
Displays selected measuring units. (ozf, Lbf, gf, kgf, or N)
- ⑭ **Overload Indicator**  
Flashes at 110% of rated capacity.

## PREPARATION

To connect the remote sensor to the ZPS display unit, rotate the round connector to find the matching groove, then push it in until positive connection is made. To disconnect, first slide the ribbed cover of the connector back, then pull out the connector (DO NOT ROTATE THE CONNECTOR WHEN PULLING OUT).

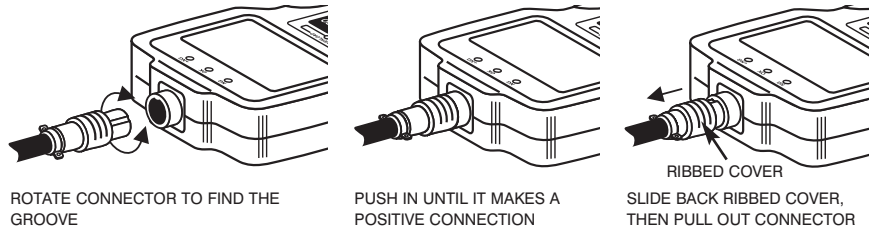

## REMOTE SENSORS

DPU both tension and compression

Low capacity: Box Type ( $\pm 0.2\%$  F.S.;  $\pm 1$  LSD)

High capacity: S Type ( $\pm 0.2\%$  F.S.;  $\pm 1$  LSD)

LM compression only ( $\pm 0.5\%$  F.S.;  $\pm 1$  LSD)

**IMPORTANT:** Load applying surface must be flat

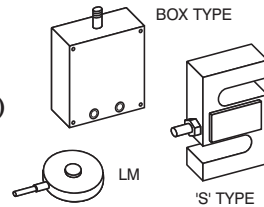

## OPERATION

### Selecting Units

Press **ON/OFF** to turn on the gauge. The LCD display briefly shows the capacity of the gauge and then zero with a measuring unit (factory setup is lbf). If you want to change to other units:

1. Turn off the gauge.
2. Press **ON/OFF** again while holding **ZERO** to enter Power-Off programming mode (CF9 flashes with solid nn0).
3. Press **SEND** to display U-03 with a unit, then press **PEAK** or **ZERO** to cycle desired units (ozf or lbf, gf or kgf, and N), and press **SEND** to select (CF9 flashes with solid End).
4. Press **ON/OFF** to exit 1st. programming mode.

Once units are selected, the gauge retains them as a default.

## Installing Microsoft .NET Framework

Microsoft .NET Framework 1.1 or later must be installed prior to running ZP Logger software. If Microsoft.NET Framework 1.0 has been previously installed it must be removed.

1. Check to see if you already have the .NET Framework installed by clicking Start on your Windows desktop, selecting Control Panel, and then double-clicking the Add or Remove Programs icon. When that window appears, scroll through the list of applications. Highlight and remove all .NET applications earlier than version 1.1. If you see Microsoft .NET Framework 1.1 listed, you do not need to install it again. Proceed to install ZP Logger.

2. Once you have removed versions earlier than 1.1 or if no Framework is installed, insert Driver CD-ROM included with your Imada force gauge. Double click the DOTNET folder and install the dotnetfx package by double-clicking the icon.

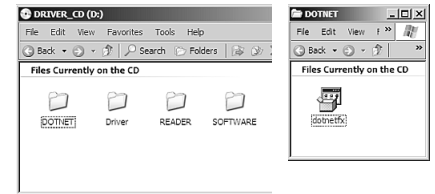

3. Eject Driver CD-ROM and restart the computer.

## Install ZP Logger software

1. Insert the Driver CD-ROM and open the ZPR folder. Double click the ZP Logger icon.
2. Follow the on screen instructions:
3. Choose "close" when installation is complete.
4. Eject the Driver CD-ROM.



## ZP Logger

ZP Logger is a USB software utility that can download and log all data stored in gauge memory and log all force values sent to gauge memory while the gauge is online. ZP logger saves data files in CSV format.

## Install USB driver

1. Turn on the gauge and confirm the USB caption is visible on the gauge display (If you have already installed the USB Driver for ZP Recorder you do not have to do it again).

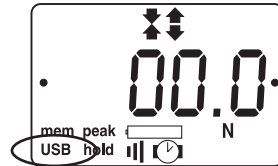

If the caption is not present turn off the gauge.

Press **ON/OFF** again while holding **ZERO**, CF9 flashes with solid m0. Press **PEAK** or **ZERO** to cycle CF9m0, CF9m1, CF9m2, CF9m3 and CF9End. When CF9 m3 appears press **SEND** to select. Then press **PEAK** or **ZERO** to cycle. 'USb': USb output or '232C': RS232 output. Press **SEND** to select 'USb', CF9End displays, press **SEND** to exit.

2. Connect the ZP, ZPH or ZPS force gauge to computer with the USB cable provided. Welcome to the Found New Hardware Wizard should appear.
3. Insert the Driver CD-ROM (included with force gauge) and select "install software automatically." Click Next and follow onscreen instructions. When prompted to search the Web select "No not this time" and click Next.
4. If a Windows XP compatibility message appears, select "continue anyway."
5. After the ZP driver is installed select "Finish."



## Reversing the Display

The factory default is standard display.

To reverse the display:

1. Turn on the gauge
2. Press **PEAK** and **ZERO** for 3 seconds to enter Power-On programming mode (CF9 flashes with solid F0).
3. Press **PEAK** 5 times to display flashing CF9 with solid F5, then press **SEND** to display -12345. Press **PEAK** or **ZERO**, to cycle between standard and reverse 5757I- .
4. Press **SEND** to select, the display flashes CF9 with solid End.
- 5 Press **SEND** again to exit Power-On programming mode.

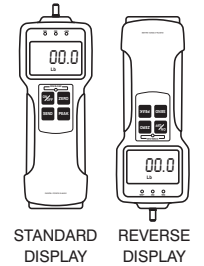

Once desired display is selected, the gauge retains it as a default.

## Programming Setpoints (optional)

Program High and Low setpoints for easy GO/NO GO testing.

1. Turn on the gauge
2. Press **PEAK** and **ZERO** for 3 seconds to enter Power-On programming mode (CF9 flashes with solid F0).
3. Press **PEAK** to display flashing CF9 with solid F1, then press **SEND** to display -HI- and then the high set value (i.e. H 10.0).
4. Press **PEAK** to increase and **ZERO** to decrease the High set value, then press **SEND** to display -LO- and then low set value (i.e. L 5.0). Press **PEAK** to increase and **ZERO** to decrease the Low set value and press **SEND** to display flashing CF9 with solid End.
5. Press **SEND** again to exit Power-On programming mode.



**Hand Tighten** (No tools!) the selected attachment to the measuring shaft.

## Peak or Real time Measuring Mode

Press **ON/OFF** to turn on and the gauge automatically enters real time measuring mode. For peak measurement press **PEAK**. The “Peak icon” appears on the display. Peak readings will not change until a higher value is measured. Press **PEAK** again to return to real time mode.

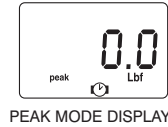
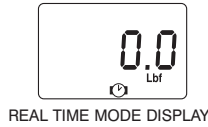

“Or PEAK“ is the factory default which measures peak compression or peak tension. “And PEAK“ measures both peak compression and peak tension during a test. Refer to the F2 function of the Power-On programming table for the “And PEAK” function.

## Tare

If necessary, press **ZERO** to tare the weight of the attachment and shaft orientation. Pressing **ZERO** also clears the peak reading.

## Caution

Make sure to apply tension or compression forces in line with the measuring shaft.

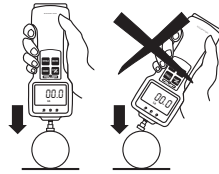

If High and Low setpoints have been programmed (see page 5), for example, 5 lbf is set as Low and 10 lbf as High, the ORANGE LED light for measurements less than 5 lbf (Low setpoint). GREEN lights between 5–10 lbf and RED lights over 10 lbf (High setpoint). Setpoint output is available through the Communications port (see page 7).

## STORING AND COLLECTING DATA

During measurement, either Peak or Real Time, press **SEND** to store up to 1000 force values into memory. (If no data is stored ----- is displayed then flashing CF9 with solid End).

Connect the gauge and a PC with a USB or CB-204 cable. Press **SEND** and data is simultaneously stored in memory and transmitted to the PC. Use optional ZP Recorder, SW-1 (see page 11) or other software to collect and display force data.

## Power-Off programming (clear data from memory)

Turn off the gauge. Press **ON/OFF** again while holding **SEND** to enter memory mode.

### Memory clear

Memory location and value cycle. Press PEAK or ZERO to increase or decrease memory location (and corresponding value).

Single Memory Clear A memory location with a dot at both ends is the last stored data and the only one that can be erased. Press SEND to erase, ErASed is displayed. If you attempt to erase other locations Error is displayed. Press ON/OFF to exit.

All Memory Clear While a memory value or location is displayed, press SEND for 3 seconds, all data is erased and ErASed is displayed, then ----- . Press ON/OFF to exit.

## Power-Off programming

Turn off the gauge Press **ON/OFF** again while holding **ZERO** to enter Power-Off programming (CF9 flashes with solid m0). Press **PEAK** or **ZERO** to cycle CF9m0, CF9m1, CF9m2, CF9m3(USB models only) and CF9End. Press **SEND** to select a function.

### CF9 m0 Units selection

Press PEAK or ZERO to cycle: 'U-01': kgf, 'U-02': N, 'U-03': lbf  
Press SEND to select, CF9End displays. Press SEND to exit.

### CF9 m1 Force dampening

Default='Fd0'

Press PEAK or ZERO to cycle: 'Fd0, Fd 1, Fd2, Fd3, Fd4, Fd5 or Fd6'. Force dampening averages rapid force changes over time. Fd0=1mS, Fd1=8mS, Fd2=16mS, Fd3=32mS, Fd4=64mS, Fd5=128mS, Fd6=256mS Press SEND to select, CF9End displays, press SEND to exit (Force dampening rate displays each time the gauge is turned on).

### CF9 m2 +/- indicator

Default='SC-OFF'

Press PEAK or ZERO to cycle. 'SC-OFF': Tension (-) and Compression (+) or 'SC-On': Tension (+) and Compression (-). Press SEND to select, CF9End displays, press SEND to exit.

### CF9 m3 Usb indicator

Default=USb

Press PEAK or ZERO to cycle. 'USb': Usb output or '-----': RS232 output. Press SEND to select, CF9End displays, press SEND to exit.

**Note:** All power-on and power-off programming functions except for unit selection and display orientation can be reset to factory defaults by the following procedure.

Turn on the gauge Press PEAK and ZERO for 3 seconds to display flashing CF9 with solid F0. Press ZERO and PEAK for 5 seconds until flashing CF9 disappears and becomes only solid F0. Then release both PEAK and ZERO. Gauge goes back to measuring mode with factory default settings.

## Power-On programming

Turn on the gauge. Press **PEAK** and **ZERO** for 3 seconds to enter Power-On programming (CF9 flashes with solid F0). Press **PEAK** or **ZERO** to cycle CF9 F0, CF9 F1, CF9 F2, CF9 F3, CF9 F4, CF9 F5, CF9 F6 and CF9 End. Press **SEND** to select a function.

<b>CF9 F0</b>	<b>Memory recall</b>	
Press SEND, memory location and value cycle. Press PEAK or ZERO to increase or decrease memory number (and corresponding value).		
<b>CF9 F1</b>	<b>High &amp; low setpoints</b>	Default='0' both Hi and Lo
Press SEND, -HI- displays, then the high set value (i.e. H 10.0). Press PEAK to increase and ZERO to decrease, press SEND to select. -LO- displays then the low set value (i.e. L 5.0). Press PEAK to increase and ZERO to decrease, press SEND to select, CF9 End displays. Press SEND again to exit.		
<b>CF9 F2</b>	<b>Peak mode</b>	Default='Or'
Press SEND, 'Or' or 'And' displays. Press PEAK or ZERO to cycle. Press SEND to select. 'Or Peak' records the Peak in either compression or tension during test. 'And Peak' records both the compression peak and tension peak during a test.		
	<b>Zero reset memory store</b>	Default='AA-OFF'
Auto memory displays after Peak mode is selected. 'AA-On' enables automatic memory storage and reset to zero. 'AA-OFF' turns off auto function. Press PEAK or ZERO to change. Press SEND to select, CF9End displays, press SEND again to exit.		
<b>CF9 F3</b>	<b>Auto zero reset</b>	Default='Ac-OFF'
Press SEND, 'Ac-On' or 'Ac-OFF' displays. Press PEAK or ZERO to cycle. If 'Ac-On' is selected, auto zero reset duration can be programmed. Press PEAK to increase or ZERO to decrease. Press SEND to select, CF9End displays, press SEND again to exit (i.e. 'SEC 3.0' is displayed for auto zero reset duration of 3 seconds).		
<b>CF9 F4</b>	<b>Audible beep</b>	Default='Sd-On'
Press SEND, 'Sd-On' for alarm on, or 'Sd-OFF' for off displays. Press PEAK or ZERO to cycle. Press SEND to select. CF9End displays, press SEND again to exit (alarm sounds for values over HI or under LO setpoints).		
	<b>Setpoint alarm</b>	Default=''
Setpoint alarm displays after audible beep is selected. 'AL-On' for setpoint alarm on or 'AL-OFF' for off. Press PEAK or ZERO to cycle. Press SEND to select, CF9End displays, press SEND again to exit.		
<b>CF9 F5</b>	<b>Reverse display</b>	
Press SEND, '-12345' for standard or '᠑᠗᠘ᠯ-' for reverse displays. Press PEAK or ZERO to cycle. Press SEND to select. Flashing CF9 with solid End displays. Press SEND again to exit. (for vertical mounting).		
<b>CF9 F6</b>	<b>Auto power off duration</b>	Default='AO-10'
Press SEND, 'AO-10' displays. Press PEAK or ZERO to cycle 'AO-5' for 5 min auto power off duration, 'AO-10' for 10 min, 'AO-30' for 30 min, 'AO-60' for 60 min and 'AO-OFF' to by-pass auto power off. Press SEND to select, CF9End displays, press SEND again to exit.		

## Recalling Data from Memory

1. Turn on the gauge.
2. Press **PEAK** and **ZERO** for 3 seconds to enter Power-On programming (CF9 flashes with solid F0). Press **SEND** and the display cycles memory location and value. Press **PEAK** to increase location and **ZERO** to decrease. Press **SEND** to exit.

## Clearing Data from Memory

1. Turn off the gauge.
2. Press **ON/OFF** again while holding **SEND** to enter memory mode.

### Single Memory Clear

A memory location number that is displayed with a dot at both ends is the last stored data and is the only one that can be erased. Press **SEND** to erase and ErASEd is displayed. If you attempt to erase any other memory location Error is displayed. If all data is erased, - - - - - is displayed then flashing CF9 with solid End. Continue Power-On programming or press **SEND** to exit (See page 18).

### All Memory Clear

While a memory value and location are displayed, press **SEND** for 3 seconds, all data is erased and ErASEd is displayed, then - - - - -. Continue Power-On programming or press **SEND** to exit.

## Downloading Data from Memory

Choose between the following download methods.

### RS-232C Data Download from Memory

Connect the gauge and device receiving data with a CB-204 cable. Use the I[CR] ASCII command to transmit data (uppercase ASCII character format).

### USB Data Download from Memory

Use ZP Logger software to download data from memory using USB, see pages 16-19.

## COMMUNICATIONS PORT

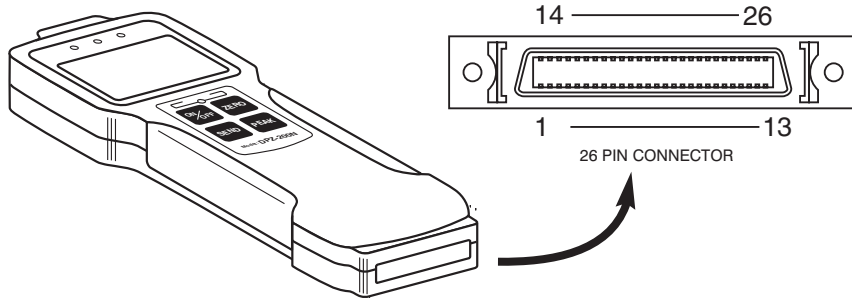

## COMMUNICATIONS PORT PIN DEFINITIONS

PIN#	DEFINITION	
1	RS-232C Signal Output	RS-232C Output
2	RS-232C Receive Signal	
3	RS-232C Ground	
4	Analog Output $\pm 2$ VDC	Analog Output
5	Analog Ground	
6		External Inputs
7		
8	External Switch Display Clear	
9		
10	External Switch Display Freeze	
11		
12	Ground	
13	Ground	
14		
15		
16		<p>High/Low Setpoint and Overload Output (open collector = 30V, 10mA max)</p>
17		
18		
19		
20		
21	+NG Output	
22	OK Output	
23	-NG Output	
24	Overload Output	
25	Common	
26	Common	

## ZP, ZPS DIMENSIONS

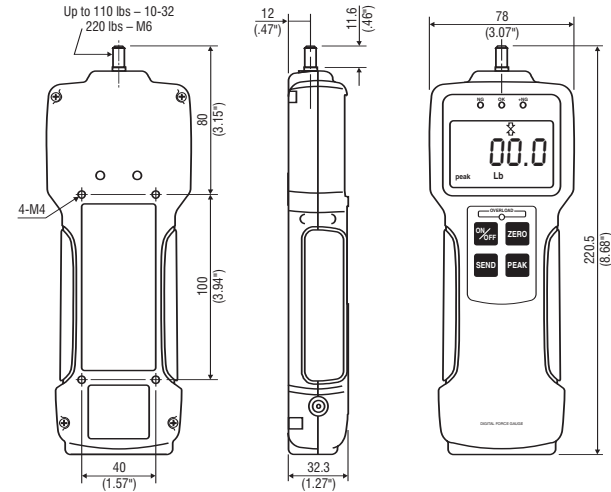

## ZPH DIMENSIONS

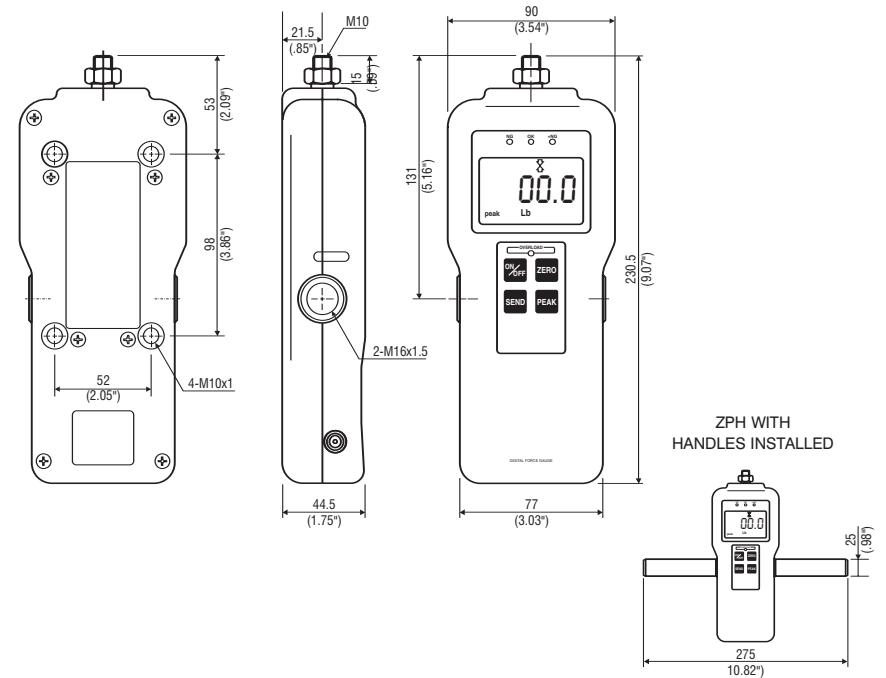

# Imada Z Series Specifications

Models: ZP, ZPH and ZPS

<b>Accuracy</b>	± 0.2% ± 1 LSD
<b>Selectable Units</b>	ozf or lbf, gf or kgf, and Newtons
<b>Overload Capacity</b>	200% of F.S. Overload indicator flashes beyond 110% of F.S.
<b>Power</b>	Rechargeable Ni-MH battery pack or Imada AD120/230 adapter
<b>Battery Indicator</b>	Icon flashes when battery is low
<b>Battery Life</b>	approx. 8 hours (recharge time approx. 10 hours)
<b>Memory</b>	Non-volatile, recall up to 1000 data
<b>Setpoints</b>	Programmable high/low setpoints with color-coded LED indicators and output signal
<b>Outputs</b>	USB, RS-232C and ± 2 VDC analog output
<b>Auto Zero Reset</b>	1.0 to 25.5 sec (selectable)
<b>Electronic Dampening</b>	7 levels (selectable)
<b>Auto Power Off</b>	5, 10, 30, 60 minutes or OFF (selectable)
<b>Operating Temp.</b>	32° to 100°F (0° to 40°C)

Ranges (Resolution) Accuracy: ±0.2% F.S. ±1 LSD

Model	Capacity (Resolution)		
	Ounces/Pounds	Grams/Kilograms	Newtons
ZP-0.4	7.00 ozf (0.01 ozf)	200.0 gf (0.1 gf)	2.000 N (0.001 N)
ZP-1	18.00 ozf (0.01 ozf)	500.0 gf (0.1 gf)	5.000 N (0.001 N)
ZP-4	4.400 lbf (0.001 lbf)	2.000 kgf (0.001 kgf)	20.00 N (0.01 N)
ZP-11	11.00 lbf (0.01 lbf)	5.000 kgf (0.001 kgf)	50.00 N (0.01 N)
ZP-44	44.00 lbf (0.01 lbf)	20.00 kgf (0.01 kgf)	200.0 N (0.1 N)
ZP-110	110.0 lbf (0.1 lbf)	50.00 kgf (0.01 kgf)	500.0 N (0.1 N)
ZP-220	220.0 lbf (0.1 lbf)	100.0 kgf (0.1 kgf)	1000 N (1 N)

Model	Capacity (Resolution)		
	Pounds	Kilograms	Newtons
ZPH-440	440.0 lbf (0.1 lbf)	200.0 kgf (0.1 kgf)	2000 N (1 N)
ZPH-1100	1100 lbf (1 lbf)	500.0 kgf (0.1 kgf)	5000 N (1 N)

Model	Capacity (Resolution)		
	Ounces/Pounds	Grams/Kilograms	Newtons
ZPS-0.4	7.00 ozf (0.01 ozf)	200.0 gf (0.1 gf)	2.000 N (0.001 N)
ZPS-1	18.00 ozf (0.01 ozf)	500.0 gf (0.1 gf)	5.000 N (0.001 N)
ZPS-4	4.400 lbf (0.001 lbf)	2.000 kgf (0.001 kgf)	20.00 N (0.01 N)
ZPS-11	11.00 lbf (0.01 lbf)	5.000 kgf (0.001 kgf)	50.00 N (0.01 N)
ZPS-44	44.00 lbf (0.01 lbf)	20.00 kgf (0.01 kgf)	200.0 N (0.1 N)
ZPS-110	110.0 lbf (0.1 lbf)	50.00 kgf (0.01 kgf)	500.0 N (0.1 N)
ZPS-220	220.0 lbf (0.1 lbf)	100.0 kgf (0.1 kgf)	1000 N (1 N)
ZPHS-440	440.0 lbf (0.1 lbf)	200.0 kgf (0.1kgf)	2000 N (1N)
ZPHS-1100	1100 lbf (1 lbf)	500.0 kgf (0.1kgf)	5000 N (1N)
ZPHS-2200	2200 lbf (1 lbf)	1000 kgf (1kgf)	10.00 KN
ZPHS-4400	4400 lbf (1 lbf)	2000 kgf (1kgf)	20.00 KN (.01 KN)

Specifications subject to change without notice.

## 1. RS-232C bi-directional interface functions

All functions can be duplicated from a remote location by using the RS-232C interface. All commands must be sent in uppercase ASCII character format followed by a carriage return [CR].

Signal level: RS-232C

Data bits: 8 bits

Stop bits: 1 bit

Parity bits: No

Baud Rate: 19200 bps

### RS-232C INTERFACE FUNCTIONS (Upper case ASCII format)

COMMAND	FUNCTION	RESPONSE
<b>T[CR]</b>	Select real time mode	R[CR]
<b>P[CR]</b>	Select peak mode	R[CR]
<b>Z[CR]</b>	Tare Display	R[CR]
<b>D[CR]</b>	Transmit display data	[direction][value][units][mode][go/nogo/overload][CR] [direction] + =compression - =tension [value] 4 digits w/decimal point [units] K, N, or O [mode] T=real time value P=peak value H=Hold value M=Memory value [go/nogo] H=+NG O=OK L=-NG E=Overload
<b>K[CR]</b>	Select "kg" units	R[CR]
<b>N[CR]</b>	Select "N" units	R[CR]
<b>O[CR]</b>	Select "lb" units	R[CR]
<b>B[CR]</b>	Delete last data stored in memory	R[CR]
<b>M[CR]</b>	Store data	R[CR]
<b>I[CR]</b>	Recall memory data	Data format is the same as D command response. It will output END[CR] at the end of data
<b>C[CR]</b>	Clear memory	R[CR]
<b>EXXXYYYY[CR]</b>	Set high/low setpoints XXXX=High(4 digit) YYYY=Low(4 digit)	R[CR]
<b>E[CR]</b>	Read high/low setpoint values	EXXXYYYY[CR] XXXX=High(4 digit) YYYY=Low(4 digit)

## 2. ±2 VDC Analog Signal

Connect the CB-104 analog cable to the communications port and the device receiving the data.

## 3. External Switch Display Freeze

By connecting #10 and #12 of the communications port, the gauge instantaneously captures the critical reading and holds the display from remote locations.

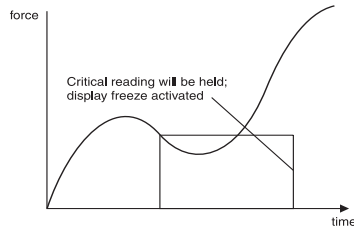

- (1) Pay extra attention to avoid overload as display value will not change during display hold.
- (2) Use contact closure only and **DO NOT** apply voltage across #10 and #12 port pins.

## 4. External Switch Display Clear

By connecting #8 and #12 of the communications port, display can be cleared from remote locations.



Use contact closure only and **DO NOT** apply voltage across #8 and #12 port pins.

## RECHARGING Ni-MH BATTERY

1. To maximize battery life, power automatically shuts off after 10 minutes of non-use or user-defined interval. Auto shut off is bypassed during USB output or when using the AC adapter/charger.
2. The battery icon flashes when the gauge needs to be recharged. It takes 10 hours to charge fully.
3. Push  to turn off power. Only use the IMADA AC adapter/charger provided, AD120 for 115VAC, AD230 for 230VAC. Plug into the correct AC output.
4. When the gauge is turned off, make sure the AC adapter/charger is disconnected to avoid overcharging.

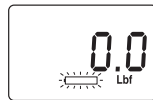

## Optional Data Acquisition Software

ZP Recorder captures and processes 1,000 data/second using a USB port. A graph of the data and statistics are displayed. Analyze all or part of the data. Compare multiple graphs.

SW-1 software captures and analyzes force data using an RS-232 port. A running log of data, graph and statistics are displayed.

## Optional Cables

CB-104 10' Analog cable

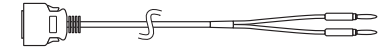

CB-204 10' RS-232C cable, 9 pin female

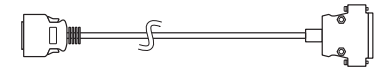

## Optional Handle

The OH-1 fits ZP gauges. Constructed of high quality steel for rugged use, the handle facilitates measurement of heavy loads. Complete with mounting screws.

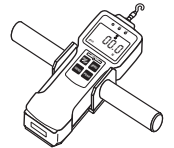

## Optional Adapter Plate

AP-001 Adapter Plate mounts IMADA low capacity gauges to most other brands of test stands.

Use the 4 screws (supplied) to mount the IMADA gauge to the AP-001 adapter plate. Then use the 2 PEM nuts on the AP-001 adapter plate to mount to other brands of test stand.

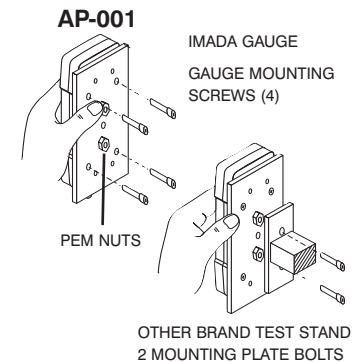

## FORCE CONTROL

Connect the Imada Z Series force gauges to an MX-Series test stand and enable force controlled testing. Force control can automatically stop testing when the force value reaches the high setpoint programmed on the Z Series force gauge, or maintain the force between the High and Low setpoints. Force control is ideal for fatigue or non-destructive testing.

