

**CHECK·LINE®**  
BY ELECTROMATIC

# DX2/DXX

## Operating Instructions



Also applies to Special Purpose Models: FX, FX2,  
RX/BX, RX2/BX2, DXFT, DX2FT, TX, TX2, KXB

Albuquerque Industrial  
69-10 108th Street # 2-O  
Forest Hills, NY 11375 U.S.A.

www.abqindustrial.net  
e-mail: info@abqindustrial.net  
Toll Free: +1 (888) 275-5772  
Tel: +1 (718) 846-6458  
Fax: +1 (718) 846-6459

**Albuquerque, Inc.**  
i n d u s t r i a l

---



---

## 7.0 DX2 MODEL DATA & SPECIFICATIONS\*

<b>Accuracy**</b>	± 1% of full scale or ± 1 graduation mark on scale
<b>Diameter of Scale</b>	41 mm
<b>Maximum Speed</b>	
(standard)	2000 m/min
(optional)	3500 m/min
(optional)	5000 m/min
<b>Outer roller distance, c:c</b>	
DX2-5 to DX2-EX	38 mm
DX2-200 to DX2-1K	100 mm
DX2-2K	150 or 200 mm
DXX-3K to DXX-5K	250 mm
<b>Roller material</b>	
(standard)	Hard-coated aluminum
(optional)	Hardened steel (ST) Chromed steel (W) Ceramic (CE) Plastic (PL)
<b>Temperature limits</b>	45–115 °F (8–45 °C)
<b>Humidity, maximum</b>	85%
<b>Housing material</b>	Die-cast aluminum
<b>Dimensions</b>	8.6 x 3.5 x 1.7 in. (225 x 90 x 44 mm)
<b>Weight (up to DX2-1K)</b>	1.1 lbs, (500 g) approx.
<b>Weight (DX2-2K)</b>	2.0 lbs, (900 g) approx.

---

\* Except for minor differences in physical dimensions, above specifications also apply to DXX instruments.

\*\* Using factory standard materials and procedures. Special calibration using customer sample is available.

Specifications subject to change without notice.

---



---

## CONTENTS

	Page
1.0 Overview & Operating Principle . . . . .	2
2.0 Operating Elements . . . . .	3
3.0 Thickness Compensation . . . . .	4
4.0 Quick Start Instructions . . . . .	5
5.0 Calibration Notes . . . . .	6
5.1 Calibration with “Standard” Filaments	
5.2 Special Calibration	
5.3 NIST Calibration	
5.4 Calibration Verification Schedule	
6.0 Options . . . . .	10
6.1 High-Speed Guide Rollers	
6.2 Lever Assembly	
6.3 Air Dashpot Damping	
6.4 Memory Pointer	
7.0 Model Data & Specifications . . . . .	12
Appendix – DX2 Special-Purpose Models . . . . .	13

---

---

## 1.0 OVERVIEW & OPERATING PRINCIPLE

DX2 and DXX Tension Meters are hand-held, mechanical instruments which accurately measure the running as well as static tensions of a wide variety of process materials including yarns, fibers, wires, optical fibers, tapes, etc. They employ the 3-roller principle for tension measurement where the outer two reference guide rollers remain fixed during measurement to establish a wrap angle over the middle sensing roller. The middle roller, acting against an internal calibrating spring, is displaced relative to the running line tension. This displacement is converted to a rotary motion to turn a pointer on a scale to give a reading in grams tension.

- NOTES:**
- 1) While illustrations show the Type DX2 Tension Meter, all references also apply to the Type DXX and Special-Purpose Tension Meters as well.
  - 2) DX2 Special Purpose Types, including FX2, TX2, DX2F, RX2/BX2 and KXB, are shown in the Appendix at the end of these instructions. They all use the 3-roller principle for tension measurement except that head configurations and roller assemblies are different, having been designed for special applications, as noted in the Appendix.

---

---

## 6.3 Air Dashpot Damping

DX2 and DXX Tension Meters incorporate a moderate amount of movement damping to smooth out some high frequency tension fluctuation. However, where process fluctuations result in rapid pointer swings which make it difficult or near impossible to read the scale, an optionally-available Air Dashpot Damping mechanism can be provided to slow down the pointer swings to permit a reading.

In setting up the mechanism, it is best to set the damping rate just to the point where a readable pointer results with minimal pointer swings. The amount of damping is set by turning the small slotted screw or hex-head screw of the damping assembly located near the guide-roller mounting bracket. The Air Dashpot must be installed at time of original manufacture. It cannot be added later.

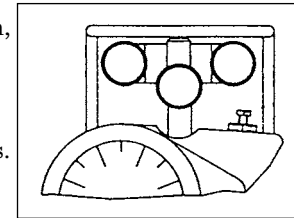

**CAUTION: Do not set damping rate too high as this will damage the movement.**

## 6.4 Memory Pointer

The optional Memory Pointer assembly retains the highest reading obtained during a measuring period. Before using the instrument, rotate the knurled pointer knob clockwise until the “memory” pointer tab contacts the measuring pointer at zero. During operation and after instrument removal, the trailing “memory” pointer will hold the maximum reading until reset with the pointer knob.

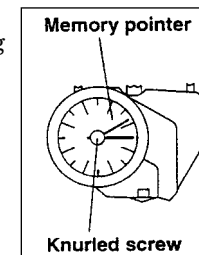

---

---

## 6.0 OPTIONS

### 6.1 High-Speed Guide Rollers

DX2 and DXX guide roller assemblies are rated 2000 meters/min., maximum. The following high-speed roller assemblies are optionally available:

“K” Roller Assembly : 3,000 meters/min., maximum  
“U” or “DHS” Assembly : 5,000 meters/min., maximum

All high speed roller assemblies must be initially installed by the factory or an authorized service facility.

### 6.2 Lever Assembly

On high-range instruments, the return spring force must be strong enough to bring the outer rollers back to their original position during measurement. The average person will find it difficult to operate the mechanism just with thumb pressure on the Thumb

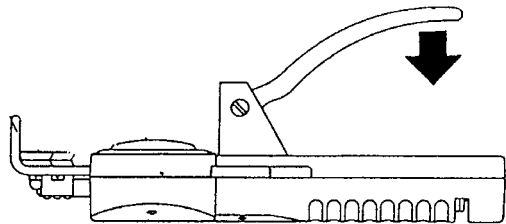

Piece alone. (This is especially true with models rated 20 kg and higher.) Adding the Lever Assembly shown here will greatly reduce the effort required to open and close the 3-roller system. The Lever Assembly must be installed by the factory or an authorized service facility.

---

---

## 2.0 OPERATING ELEMENTS

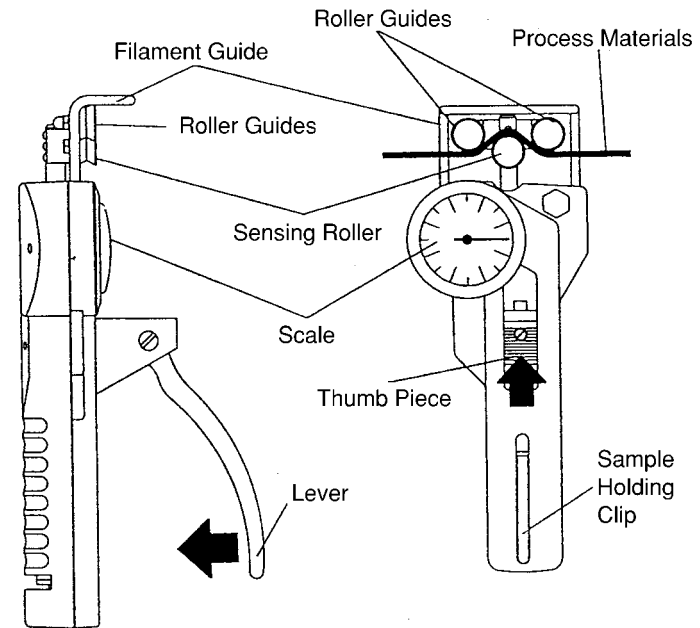

---

---

### 3.0 THICKNESS COMPENSATION

The 3-roller system for tension measurement relies on the displacement of the middle roller to give an indication of line tension. As the material diameter or thickness changes, there will be a change in tension reading, even though line tension has not changed. To offset this effect, high-range

instruments (1000 grams and higher) are usually furnished with a Thickness Compensator, as shown here. To determine whether the Compensator needs to be used for a specific application, take readings with and without the process sample in the Compensator using a hanging weight approximately equal to the process operating tension.

To set up the Thickness Compensator, proceed as follows:

1. With the Thumb Piece pushed forward and held, pass a sample of the process material through the opening at the instrument end, as pictured here, making sure it lies between the two visible disc-like anvil surfaces.
2. Allow the Thumb Piece to SLOWLY return to its original position.

**CAUTION: Do not let the Thumb Piece snap back as this may affect calibration and also damage the instrument.**

3. Secure the process sample ends under the spring clip provided or with some tape. The instrument is now ready to use

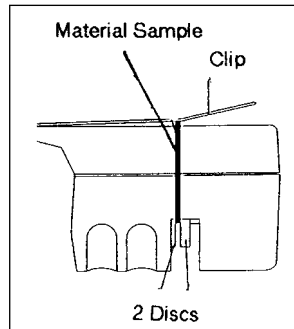

---

---

### 5.4 Calibration Verification Schedule

Frequency of calibration accuracy verification depends on many factors. These include frequency and extent of tension overloads, operating speeds, length of operating times, environment, care in handling, etc. Such determination is best made by the user's Quality Assurance Department based on the user's experience. However, a quick calibration check near the anticipated process tension levels should be done to confirm the integrity of the instrument, as follows:

1. At the beginning of each work session
2. Every time a unit is dropped
3. Whenever process readings seem to be out of tolerance for no apparent reason

The quick check can be made with a simple load stand, as shown in 5.0, above, using a sample of the process material and weights that are close to the tensions encountered in the process. Be sure to move the tension meter up and down slowly to simulate the motion of the running process material. This will check the condition of the guide roller ball bearings and remove any inertia effect of the movement. Readings that change with this motion reversal may indicate the possibility of a guide roller ball bearing problem.

In the case of wire, which might be slightly deformed by the action of the 3-roller system during static measurement, always move to a fresh portion of the wire each time a measurement is made. (In production, the instrument always "sees" a fresh portion.)

---

---

## 5.2 Special Calibration

Special Calibration is optionally available for a specific material type and size so long as the material fits the mechanical limits and range of the instrument. The customer must supply a 10-ft sample (3 meters) of the material. Such calibration can be performed with or without using the Thickness Compensator if one has been provided with the instrument. If not specified, the calibration facility will use its best judgment.

**Note:** Special calibration is available for a single sample only.

## 5.3 NIST Calibration

While all DX2 and DXX instruments are furnished with a Calibration Certificate which certifies that they have been calibrated in accordance with factory procedures and were found to meet all published accuracy specifications, such calibrations do not fulfill ISO-9000 requirements since no record of measured values are kept or are submitted. Where ISO-9000 requirements are to be met, NIST calibration is optionally available but must be specified at time of order placement or after repair.

---

---

## 4.0 QUICK START INSTRUCTIONS

**NOTE:** If tension meter is equipped with a Thickness Compensator, first set up Compensator as indicated in 3.0, above.

1. Prior to engaging the material under test, part the 3-roller system by pushing and holding the Thumb Piece forward.
2. Keeping the outer rollers extended, bring the instrument behind or under the filament and move it so that the Filament Guide bars contact the process material.
3. Slowly release pressure on the Thumb Piece until the outer rollers return to their original position. This will automatically direct the material into the guide roller grooves.
4. The scale pointer will show line tension directly in grams or kilograms.
5. To remove the instrument from the process material, push the Thumb Piece forward again to open the 3-roller system. With the outer rollers extended, move the instrument away from the material.
6. Remove the instrument and SLOWLY release pressure on the Thumb Piece, allowing the outer rollers to return to their original position.

**CAUTION: Do not let the Thumb Piece snap back as this may affect calibration and also damage the instrument.**

## 5.0 CALIBRATION NOTES

The calibration process involves hanging laboratory weights from a fixed point, engaging the vertical line material which holds the weights with the tension meter 3-roller system, marking a blank dial face where the scale pointer comes to rest for each weight used, dividing the spaces between load “reading” marks and finish marking and numbering to show calibration marks and “readings” on the dial face.

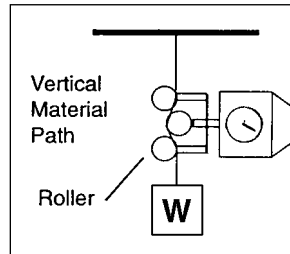

The procedure requires specialized skills and the following material:

1. A load stand to simulate the setup shown here.
2. A set of precision laboratory weights to cover the tension range of the instrument.
3. Factory “standard” nylon monofilaments as shown in the Table on page 7.
4. A Calibration Kit which includes an Alignment Plate and two (2) special metric wrenches.

A full, detailed calibration procedure is available upon request.

## 5.1 Calibration with Factory Standard Filaments

All DX2 and DXX Tension Meters are calibrated with laboratory weights suspended from factory Standard nylon monofilament sizes, as noted in the table below. Any difference in process material size and rigidity from the Standard materials may result in some error. For over 95% of applications, the error is not significant and can be ignored since readings are generally treated as production setup values or are used for comparative purposes. In those cases where highest accuracy is required, a correction chart showing Readings vs. Actual Load should be made up by the user or “Special” calibration should be specified when an order is placed.

**Standard Calibration Monofilament Sizes**

Model	Model	Range (Grams)	Mono-filament Diam. (mm)
DX2-5	DXX-5	5-50	1000 denier or 0.15 max.
DX2-12	DXX-12	10-120	0.20
DX2-20	DXX-20	10-200	0.20
DX2-40	DXX-40	10-400	0.25
DX2-SP	DXX-SP	20-1000	0.30
DX2-EX	DXX-EX	100-1000	0.30
DX2-200	DXX-200	200-2000	0.50
DX2-500	DXX-500	400-5000	0.80
DX2-1K	DXX-1K	2-10 kg	1.00
DX2-2K	DXX-2K	5-20 kg	1.20

---

---

## APPENDIX — DX2 SPECIAL-PURPOSE MODELS

Essentially, all DX2 Special Purpose models operate in a manner similar to the standard Type DX2. In addition, however, they offer special rollers and head configurations for specific applications.

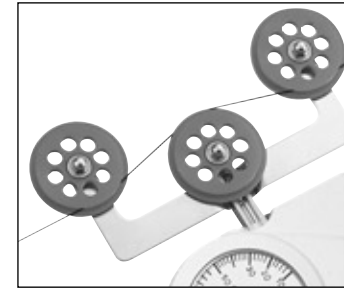

**Optic Fibers — FX2**



**Tapes — TX2**



**Limited Access — DX2F**

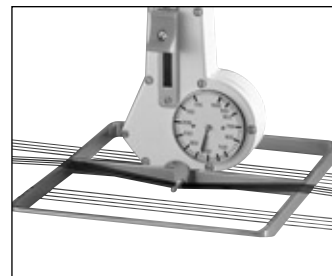

**Warp — KXB**



**Webs & Tapes — RX2/BX2**