Notes

Table of Contents

1.0 Introduction 3

- 1.1 Models
- 1.2 Unpacking

2.0 Overview 4

- 2.1 Controls
- 2.2 Complete kit
- 2.3 Optional accessories

3.0 Set-Up Procedures 5

- 3.1 Battery Insertion and Replacement
- 3.2 Power On and Off
- 3.3 Reversing the display
- 3.4 Zero adjustment of the measuring position

4.0 Taking A Measurement 7

- 4.1 Inserting the process material
- 4.2 Measuring the process material
- 4.3 Removing the process material

5.0 Damping Mode 8

- 5.1 Switching Damping on and off
- 5.2 Modifying the Damping Factor
- 5.3 Setting a new Damping Factor

6.0 Memory Modes 9

- 6.1 Memory Mode selection

7.0 Data Logging 11

- 7.1 Data logging in Mode “S” (Standard)
- 7.2 Data logging in Mode “C” (Continuous)
- 7.3 Data logging in Mode “L” (Limit)
- 7.4 Data logging in Mode “F” (Fast)

8.0 Recalling the stored tension values 15

- 8.1 Recalling stored tension values in Mode “S” (Standard)
- 8.2 Recalling stored tension values in Mode “C” (Continuous)
- 8.3 Recalling stored tension values in Mode “L” (Limit)
- 8.4 Recalling stored tension values in Mode “F” (Fast)



Albuquerque Industrial
69-10 108th Street # 2-O
Forest Hills, NY 11375 U.S.A.

www.abqindustrial.net
e-mail: info@abqindustrial.net
Toll Free: +1 (888) 275-5772
Tel: +1 (718) 846-6458
Fax: +1 (718) 846-6459

| | | |
|-------------|---|----|
| 9.0 | Memory Management | 22 |
| 9.1 | Clearing the KXE memory | |
| 9.2 | Memory function HOLD | |
| 10.0 | Error Messages | 23 |
| 11.0 | PC Communications (RS-232 Interface) | 24 |
| 11.1 | TENSION INSPECT program | |
| 11.2 | Windows Terminal Program | |
| 12.0 | Specifications | 25 |
| 13.0 | Pin Assignments | 26 |
| 13.1 | Interface Signals | |
| 13.2 | Analog Cable | |
| 14.0 | Warranty | 27 |

14.0 Warranty

The manufacturer warrants to the original purchaser that this product is of merchantable quality and confirms in kind and quality with the descriptions and specifications thereof. Product failure or malfunction arising out of any defect in workmanship or material in the product existing at the time of delivery thereof which manifests itself within one year from the sale of such product, shall be remedied by repair or replacement of such product, at the manufacturer's option, except where unauthorized repair, disassembly, tampering, abuse or misapplication has taken place, as determined by the manufacturer. All returns for warranty or non-warranty repairs and/or replacement must be authorized by the manufacturer, in advance, with all repacking and shipping expenses to the address below to be borne by the purchaser.

THE FOREGOING WARRANTY IS IN LIEU OF ALL OTHER WARRANTIES, EXPRESSED OR IMPLIED, INCLUDING BUT NOT LIMITED TO, THE WARRANTY OF MERCHANTABILITY AND FITNESS FOR ANY PARTICULAR PURPOSE OR APPLICATION. ELECTROMATIC SHALL NOT BE RESPONSIBLE NOR LIABLE FOR ANY CONSEQUENTIAL DAMAGE, OF ANY KIND OR NATURE, RESULTING FROM THE USE OF SUPPLIED EQUIPMENT, WHETHER SUCH DAMAGE OCCURS OR IS DISCOVERED BEFORE, UPON OR AFTER REPLACEMENT OR REPAIR, AND WHETHER OR NOT SUCH DAMAGE IS CAUSED BY MANUFACTURER'S OR SUPPLIER'S NEGLIGENCE WITHIN ONE YEAR FROM INVOICE DATE.

Some State jurisdictions or States do not allow the exclusion or limitation of incidental or consequential damages, so the above limitation may not apply to you. The duration of any implied warranty, including, without limitation, fitness for any particular purpose and merchantability with respect to this product, is limited to the duration of the foregoing warranty. Some states do not allow limitations on how long an implied warranty lasts but, notwithstanding, this warranty, in the absence of such limitations, shall extend for one year from the date of invoice.

Important Operating Notes



To avoid damage, do not move the center roller by hand.

Tensions that exceed the tension range of the instrument by more than 100% may cause permanent damage to the measuring spring and must be avoided under any circumstances.

The device must not be operated in potentially explosive areas and must not come into contact with aggressive substances

Every precaution has been taken in the preparation of this manual. The manufacturer, assumes no responsibility for errors or omissions. Neither is any liability assumed for damages resulting from the use of information contained herein. Any brand or product names mentioned herein are used for identification purposes only, and are trademarks or registered trademarks of their respective holders.

13.0 Pin Assignments

13.1 Pin Assignment and Signals of the Interface (9-Pin D-Sub Connector)

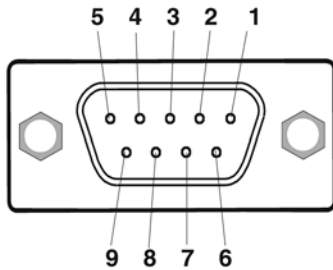

| Signal | RS-232-C |
|-----------|----------|
| Data Bit | Bit |
| Stop Bit | 1 Bit |
| Parity | None |
| Baud Rate | 19200 |

| Pin Number | Signal | Description |
|------------|--------|---------------|
| 1 | | Not Assigned |
| 2 | TXD | 1 Bit |
| 3 | RXD | None |
| 4 | | Not Assigned |
| 5 | GND | Ground |
| 6 | | Not Assigned |
| 7 | RTS | READY TO SEND |
| 8 | | Not Assigned |
| 9 | 2 V DC | Analog Signal |

13.2 Pin Assignment of the Analog Cable (Option ETX-CA)

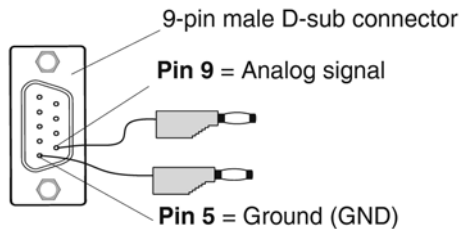

1.0 Introduction

The KXE Warp Tension Meter is designed to measure tensions during warping and weaving. The unique sensor configuration provided two 25 mm wide cylindrical roller for the capture of two groups of yarns, one on each side of the sensor for measurement. Therefore the sensor will be measuring 50 mm of ends while the process is running. The electronic indicator provides for measurement and storage of the critical high and low peaks that will be measuring in the weaving operation. These peaks can them be analyzed and used for process evaluation. Stored data can be transferred to a PC and analyzed using the FREE Tension Inspect software.

1.1 Models

KXE-20 0.5 – 20.0 daN measuring range.

KXE-50 0.5 – 50.0 daN measuring range.

1.2 Unpacking

Unpack the tension meter and inspect it for any shipping damage. Notices of defect must be filed immediately, in writing, at the latest within 10 days on receipt of the goods.

2.0 Overview

2.1 Controls

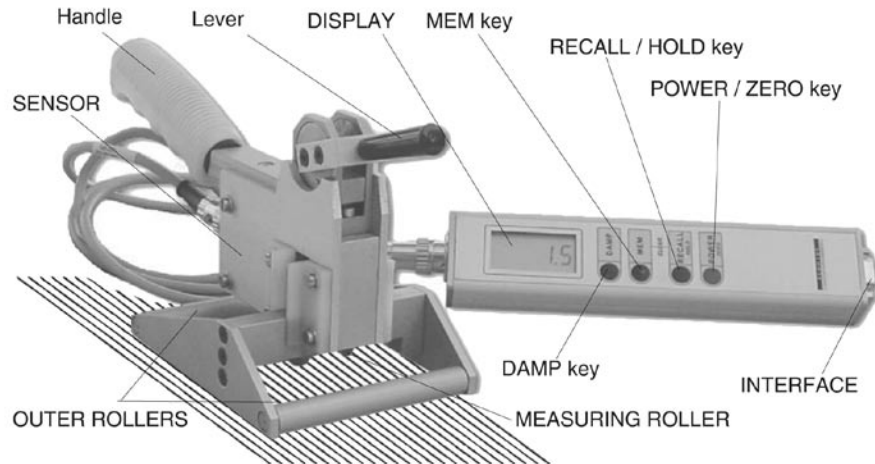

2.2 Complete kit

- XLE Tension Meter.
- 9 volt battery.
- Digital connecting cable. Part number ETC-CC.
- TENSION INSPECT software for viewing and storing measured data on a PC, requires Win 96 or higher. Part number ETC-P2.
- Operating manual.
- Carrying case.

2.3 Optional accessories

- ETX-CA** Connecting cable for analog signal.
ET-AKKU Rechargeable 9 V battery (NiCd).
ET-AC-115 Battery charger for 115 V AC.
ET-AC-230 Battery charger for 230 V AC.

12.0 Specifications

| | |
|---------------------------------|--|
| Display Unit Calibration | According to factory procedure |
| Units of Measure | daN |
| Accuracy | $\pm 1\% \text{ FS}^* \pm 1 \text{ digit}$ (typically $\pm 0.5\% \text{ FS}^*$) |
| Overrange | 10% FS*, without accuracy guarantee |
| Overload Protection | 150% FS* |
| Measuring Principle | Strain gauge bridge |
| Signal Processing | Digital 16 bit A/D converter |
| Damping | Adjustable electronically (averaging) |
| Measuring Frequency | Approx. 5 kHz internally |
| Display Update Rate | 2x per second |
| Display | 4-digit LCD, height of digit 11 mm |
| Memory | Average, last value, MAX, MIN, MAX PEAK, MIN PEAK |
| Memory Modes | 3 - for up to 4000 readings |
| Temperature Coefficient | Gain: less than $\pm 0.01\% \text{ FS}^*/^\circ\text{C}$ |
| Analog Output Signal | 0 - 2 V DC (linearized) RLoad > 1 k Ω \pm approx. 1% |
| Converter Frequency | 100 Hz |
| Digital Output Signal | RS232 (9600, 8, N, 1) (2 readings per sec.) (with Tension Inspect > 50 readings/sec possible) |
| Temperature Range | 10 - 45 ° C |
| Air Humidity | 85% RH, max. |
| Auto Power Off | Automatically after approx. 3 min. of non-use |
| Power Supply | 9 V E block 9 V lithium for about 80 hours of continuous use |
| Housing Material | Aluminium profile with plastic outer casing (PVC) |
| Housing Dimensions | 230 mm x 45 mm x 48 mm (L x W x H) |
| Weight, net (gross) | Approx. 370 g / 1050 g *FS = Full Scale |

Sensor:

| | |
|--|--------------------------------|
| Measuring Rollers | 2x 22 mm ball bearing rollers |
| Width of Outer Rollers | 100 mm (ball bearing rollers) |
| Total Width of Rollers | 50 mm |
| Reference Frame Height Adjustment | 24 mm |
| Material | Anodized aluminium |
| Dimension | 165 x 110 x 140 mm (L x W x H) |
| Weight, net (gross) | 1050 g (1500 g) |

11.0 PC Communication (RS-232-C Interface)

11.1 The TENSION INSPECT Program

The TensionInspect software from Electromatic is described in a separate user manual.

11.2 WINDOWS Terminal Program

The measured values and the memory contents can be transmitted over the RS232 interface to a personal computer. You can connect the computer to the INTERFACE of the KXE by using the ETX-CC special cable which is available as an accessory.

The pin assignment of the INTERFACE is described in Section 13.

Requirements: A communication program, such as Termina or HyperTerminal (provided on MS Windows Version 3.0 or later), must be installed and configured on the computer.

| ASCII Code | Function | Description |
|------------|-------------------------|--|
| D | Continuous transmission | Continuous transmission of the readings. press any key to stop transmission. |
| d | Send | Transmit current reading to PC once. |
| m | Save | Start logging of measuring date. Stop data logging. |
| r | Output | Output the memory contents to the PC. |
| c | Clear memory | Delete the memory content. |
| a | Damping ON/OFF | Switch damping on or off. |
| z | Zero | Carry ot zero adjustment of the instrument |
| u | Toggle unit of measure | Switch from g to cN, and vice versa |

3.0 Set-Up Procedures

3.1 Battery insertion and replacement

Before the first use of your tension meter, you need to insert the battery

1. Open the battery compatment on the rear side of the tension meter and insert a 9V battery (E Block), making sure that the polarity of the battery matches the polarity marked on the battery compartment. Close the battery compartment.

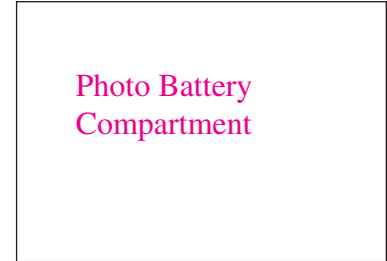

2. If the  symbol is shown on the display, the battery is low and must be replaced immediately. Operating the tension meter with a low battery may cause measurement errors.



NOTE: If the instrument will not be used for an extended period of time, the battery should be removed.

3.2 Power On/Off

Power On: Press the **POWER/ZERO** key until all symbols are shown on the display. When you release the key, the display momentarily shows the tension range and the software version, e.g. E 1.0, followed by random valuse or "0."



Power Off: Press the **POWER/ZERO** key for 5 seconds.

Auto Power Off: The tension meter switches off after 3 minutes of non use.

3.3 Reversing the display

When you shift the tension meter from the right to the left hand, you can rotate the readings on the DISPLAY by 180° to make them easier to read.

Measuring with the display unit in the left hand:

1. Switch off the tension meter switched off as described in Section 3.
2. Press and hold the **DAMP** and **POWER** keys until the display shows the readings the other way around.

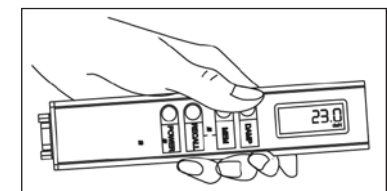

Measuring with the display unit in the right hand (default position):

1. Tension meter switched off as described in Chapter 3.2
2. Press and hold the **DAMP** and **POWER** keys until the display shows the readings in the default position.

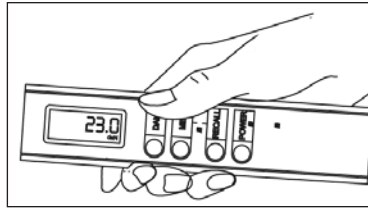

NOTE: The selected display orientation remains stored in the KXE memory even after the instrument is switched off.

3.4 Zero adjustment of the measuring position.



Before starting measurement you need to carry out zero adjustment, as described below, each time the tension meter is switched on. This procedure is necessary to compensate for the weight of the measuring roller in the measuring position. The zero adjustment for the new measuring path only remains effective until the instrument is switched off. Zero adjustment must be repeated whenever the material path is changed or the tension meter does not display “0.”

NOTE: The process material must not yet be inserted into the tension meter!

To carry out a zero adjustment:

1. Holding the **SENSOR** at the **HANDLE**, place it in the desired measuring position. Be careful to hold the instrument absolutely steady.
2. Press the **POWER** key.



The KXE is now adjusted for the new material path and is ready to measure.

10.0 Error Messages



The DISPLAY shows EEE. The upper limit of the tension range was exceeded by more than 10%. Reduce the line tension.

OR

AUTO ZERO is no longer possible. Recalibrate the instrument following the directions in Section 3.4.

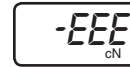

The DISPLAY shows -E.E. The lower limit of the tension range was fallen below by more than 10%. Properly insert the process material.

OR

AUTO ZERO is no longer possible. Recalibrate the instrument following the directions in Section 3.4.

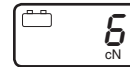

The DISPLAY shows the battery symbol. The battery is low and must be replaced immediately. Operating the tension meter with a low battery may cause measurement errors.

9.0 Memory Management

9.1 Clearing the KXE Memory

If values are stored in the KXE memory, the DISPLAY shows e.g.  with the **MEM** indicator.

To clear the memory:

1. Simultaneously press the **MEM** and **RECALL** keys.

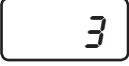
The DISPLAY shows e.g. ; all values stored in the memory have been deleted.

9.2 Memory Function HOLD

When the tension meter memory is empty, you can retain the last reading on the DISPLAY by using the memory function HOLD.

To retain the last reading:

1. Press the **RECALL / HOLD** key once for about 1 second.

The DISPLAY shows the last reading  and the “:” colon symbol.

To switch back to measuring mode:

1. Press the **RECALL / HOLD** key once for about 1 second. The tension meter switches back to measuring mode.

4.0 Taking A Measurement

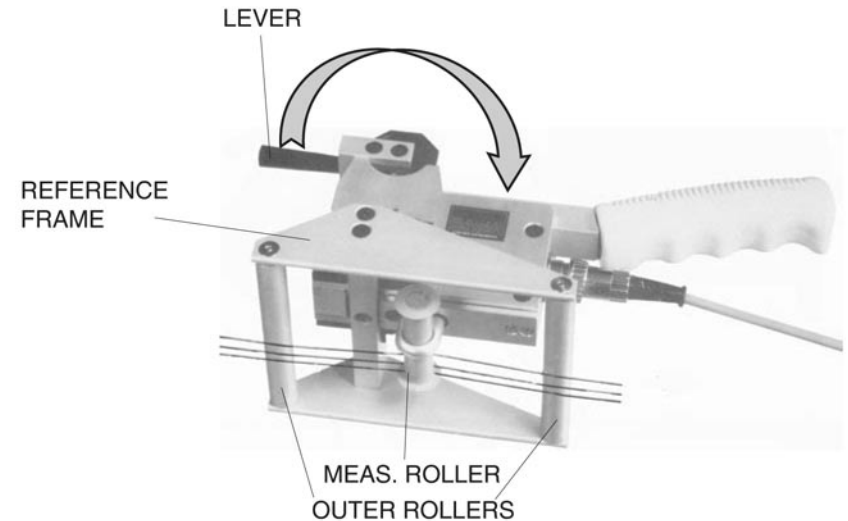

4.1 Inserting the process material

1. Turn on the power, then perform as zero adjustment as described in Section 3.4.
2. Push the **LEVER** in the direction of the arrow to lift the **REFERENCE FRAME** and the **OUTER ROLLERS**.
3. Insert the **MEASURING ROLLER** into the warp.
4. Push the **LEVER** back into the original position to move the **REFERENCE FRAME** and the **OUTER ROLLERS** down again. It is important to assure that the warp passes smoothly between the **MEASURING ROLLERS** and the **OUTER ROLLERS**.

4.2 Measuring the process material:

The display now shows the measured tension values. Error messages which might be displayed are described in Section 10.0

4.3 Removing the process material:

1. Push the **LEVER** in the direction of the arrow to lift the **REFERENCE FRAME** and the **OUTER ROLLERS**.
2. Remove the **MEASURING ROLLER** from the warp.

5.0 Damping Mode

The KXE is equipped with an electronic damping which ensures steady readings when tension fluctuates. This is achieved by averaging the measured values at the set update rate.

NOTE: Before switching on the damping mode, it is recommended that you measure the first values without damping enabled.

5.1 To switch damping on and off:

1. Insert process material and take a measurement as directed in Section 4.0

2. Press the **DAMP** key. The display shows the set damping factor.

3. Release the **DAMP** key.

The display shows **DAMP** below the currently measured value.



3. To switch off damping, press the **DAMP** key again.

The display shows only the currently measured value.



5.2 Modifying the Damping Factor

The tension meter is factory preset to a damping factor of 12. The tension values are averaged for the display in the following way:

$\frac{12 \text{ old values} + 4 \text{ new values}}{16}$

16

The damping factor can be modified in 15 steps from 01 = low damping:









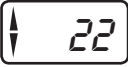

$\frac{1 \text{ old value} + 15 \text{ new values}}{16}$

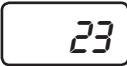
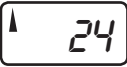

16

to 15 = high damping:

$\frac{15 \text{ old values} + 1 \text{ new value}}{16}$

16

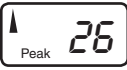
3. The DISPLAY blinks, showing  the **average value** (AVG) of the first measuring period (POS: 1) and the  symbol.
4. Press the **RECALL** key. The DISPLAY blinks, showing  the **last value** (LAST) of the measuring period.
5. Press the **RECALL** key. The DISPLAY blinks, showing  the **maximum value** (MAX) of the measuring period and the  symbol.
6. Press the **RECALL** key. The DISPLAY blinks, showing  the **minimum value** (MIN) of the measuring period and the  symbol.
7. Press the **RECALL** key. The DISPLAY blinks, showing  the **maximum peak value** (PEAK MAX) of the measuring period, the PEAK indicator and the  symbol.
8. Press the **RECALL** key. The DISPLAY blinks,  showing the **minimum peak value** (PEAK MIN) of the measuring period, the PEAK indicator and the  symbol.
9. Press the **RECALL** key. The measured values no. 1 — 10 of the first measuring period can be recalled.
10. Press the **RECALL** key. The next measuring period (POS: 2) is shown on the DISPLAY and the sequence is repeated, starting with the **average** value (AVG).

7. Press the **RECALL** key. The DISPLAY blinks, showing  the **maximum peak value** (PEAK MAX) of the measuring period, the PEAK indicator and the \blacktriangle symbol
8. Press the **RECALL** key. The DISPLAY blinks,  showing the **minimum peak value** (PEAK MIN) of the measuring period, the PEAK indicator and the \blacktriangledown symbol.
9. Press the **RECALL** key. The measured values no. 1 — 10 of the first measuring period can be recalled.
10. Press the **RECALL** key. The next measuring period (POS: 2) is shown on the DISPLAY and the sequence is repeated, starting with the **average** value (AVG).

8.4 Recalling the Stored Tension Values in Mode “F” FAST

1. Tension meter switched on as described in Chapter 3.3.1.
2. Press the **RECALL** key.

NOTE: You can end recall any time by pressing the **POWER** key.

| Memory Mode CONTINUOUS | | | | | | | |
|------------------------|------|-----------------------|------|-----------------------|------|-----------------------|------|
| Pos: | 1 | Pos: | 12 | Pos: | 3 | Pos: | 4 |
| AVG: | 22.0 | AVG: | 12.0 | AVG: | 12.0 | AVG: | 12.0 |
| Last: | 23.0 | Last: | 22.1 | Last: | 22.1 | Last: | 22.1 |
| MAX: | 24.0 | MAX: | 22.1 | MAX: | 22.1 | MAX: | 22.1 |
| MIN: | 21.0 | MIN: | 5.4 | MIN: | 5.4 | MIN: | 5.4 |
| PEAK _{MAX} : | 26.0 | PEAK _{MAX} : | 28.1 | PEAK _{MAX} : | 28.1 | PEAK _{MAX} : | 28.1 |
| PEAK _{MIN} : | 19.0 | PEAK _{MIN} : | 1.8 | PEAK _{MIN} : | 1.8 | PEAK _{MIN} : | 1.8 |
| | 10.8 | | 14.2 | | 14.1 | | 15.4 |
| | 10.0 | | 19.4 | | 11.2 | | 18.3 |
| | 7.3 | | 22.9 | | 8.9 | | 17.5 |
| | 6.1 | | 17.3 | | 10.2 | | 7.8 |
| | | | | | | | |
| | n | | n | | n | | n |

5.3 Setting a new Damping Factor

1. Press and hold the **DAMP** key. The display shows the set damping factor.
2. You can now increase the damping factor by pressing the **MEM** key and decrease it by pressing the **RECALL** key.
3. Once the new factor appears on the display, release the **DAMP** key. The tension meter switches back to measuring mode.

NOTE: The selected damping factor remains stored in the KXE memory even after the instrument is switched off.

6.0 Memory Modes

The tension meter features a data logger with a memory capacity for up to 4000 readings, with which you can store different measuring periods at one or more machine positions. The readings are saved 2x per second, synchronously with the display update rate, in all memory modes except the “F” mode in which they are saved 100x per second. All saved readings and statistics can be shown on the display or transmitted to a PC (e.g. for further processing in Excel). The memory can be allocated to different measuring periods, depending on the memory mode.

| Memory Mode | S | C | L | F |
|-----------------------------------|-----|------|------|------|
| Meas. periods, max. | 255 | 255 | 255 | 255 |
| Readings, max. | – | 4000 | 4000 | 4000 |
| Max. no. of readings per position | – | Any | 10 | Any |
| Statistics | Yes | Yes | Yes | Yes |
| Save Readings | – | Yes | Yes | Yes |

NOTE: The selected memory mode remains stored in the KXE memory even after the instrument is switched off.

Memory mode “S” STANDARD (default)

The following values of a measuring period are calculated and saved at a rate of 2 readings per second:

- Average value,
- Last value,
- Maximum value (MAX),
- Minimum value (MIN),
- Minimum peak value (MIN PEAK)
- Maximum peak value (MAX PEAK)

Individual readings are not saved. You can save up to 255 measuring periods.

Memory mode “C” CONTINUOUS:

The following values of a measuring period are calculated and all readings are additionally saved at a rate of 2 readings per second:

Average value,
 Last value,
 Maximum value (MAX),
 Minimum value (MIN),
 Minimum peak value (MIN PEAK),
 Maximum peak value (MAX PEAK)

You can save up to 4000 readings, split up into up to 255 measuring periods.

Memory mode “L” LIMIT:

The following values of a measuring period are calculated and 10 readings are additionally saved at a rate of 2 readings per second:

Average value,
 Last value,
 Maximum value (MAX),
 Minimum value (MIN),
 Minimum peak value (MIN PEAK),
 Maximum peak value (MAX PEAK)

You can save up to 255 measuring periods with 10 readings each.

Memory mode “F” FAST:

The following values of a measuring period are calculated and all readings are additionally saved at a rate of 100 readings per second:

Average value,
 Last value,
 Maximum value (MAX),
 Minimum value (MIN),
 Minimum peak value (MIN PEAK),
 Maximum peak value (MAX PEAK)







You can save up to 4000 readings, split up into up to 255 measuring periods.



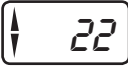

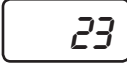
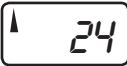

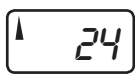

8.3 Recalling the Stored Tension Values in Mode “L” LIMIT

1. Tension meter switched on as described in Chapter 3.2.
2. Press the **RECALL** key.

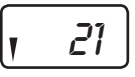
NOTE: You can end recall any time by pressing the **POWER** key.

| Memory Mode CONTINUOUS | | | | | | | |
|------------------------|------|-----------------------|------|-----------------------|------|-----------------------|------|
| Pos: | 1 | Pos: | 12 | Pos: | 3 | Pos: | 4 |
| AVG: | 22.0 | AVG: | 12.0 | AVG: | 12.0 | AVG: | 12.0 |
| Last: | 23.0 | Last: | 22.1 | Last: | 22.1 | Last: | 22.1 |
| MAX: | 24.0 | MAX: | 22.1 | MAX: | 22.1 | MAX: | 22.1 |
| MIN: | 21.0 | MIN: | 5.4 | MIN: | 5.4 | MIN: | 5.4 |
| PEAK _{MAX} : | 26.0 | PEAK _{MAX} : | 28.1 | PEAK _{MAX} : | 28.1 | PEAK _{MAX} : | 28.1 |
| PEAK _{MIN} : | 19.0 | PEAK _{MIN} : | 1.8 | PEAK _{MIN} : | 1.8 | PEAK _{MIN} : | 1.8 |
| | 10.8 | | 14.2 | | 14.1 | | 15.4 |
| | 10.0 | | 19.4 | | 11.2 | | 18.3 |
| | 7.3 | | 22.9 | | 8.9 | | 17.5 |
| | 6.1 | | 17.3 | | 10.2 | | 7.8 |
| | | | | | | | |
| | n | | 10 | | 10 | | 10 |

3. The DISPLAY blinks, showing  the **average value** (AVG) of the first measuring period (POS: 1) and the  symbol.
4. Press the **RECALL** key. The DISPLAY blinks, showing  the **last value** (LAST) of the measuring period.
5. Press the **RECALL** key. The DISPLAY blinks, showing  the **maximum value** (MAX) of the measuring period and the  symbol.
6. Press the **RECALL** key. The DISPLAY blinks, showing  the **minimum value** (MIN) of the measuring period and the  symbol.

5. Press the **RECALL** key. The DISPLAY blinks, showing  the **maximum value** (MAX) of the measuring period and the  symbol.
6. Press the **RECALL** key. The DISPLAY blinks, showing  the **minimum value** (MIN) of the measuring period and the  symbol.
7. Press the **RECALL** key. The DISPLAY blinks, showing  the **maximum peak value** (PEAK MAX) of the measuring period, the PEAK indicator and the  symbol
8. Press the **RECALL** key. The DISPLAY blinks,  showing the **minimum peak value** (PEAK MIN) of the measuring period, the PEAK indicator and the  symbol.
9. Press the **RECALL** key. The measured values no. 1 — n of the first measuring period can be recalled.
10. Press the **RECALL** key. The next measuring period (POS: 2) is shown on the DISPLAY and the sequence is repeated, starting with the **average** value (AVG).

6.1 Memory Mode Selection

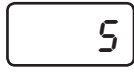
1. Turn on the tension meter and clear the memory by simultaneously pressing the **MEM** and **RECALL** keys.
2. Press and hold the **MEM** key. The display shows **S** . Press the **DAMP** or **RECALL** key to change the memory mode.

MEMORY MODE “S” STANDARD (default) 
If the display shows S. The STANDARD memory mode is set.

MEMORY MODE “C” CONTINUOUS 
If the DISPLAY shows C, the CONTINUOUS memory mode is set.

MEMORY MODE “L” LIMIT 
If the DISPLAY shows L, the LIMIT memory mode is set.

MEMORY MODE “F” FAST 
If the DISPLAY shows F, the FAST memory mode is set.

When you have selected the desired memory mode, you can release the **MEM** key. The selected memory mode is now active and the tension meter switches back to measuring mode.

NOTE: The selected memory mode remains stored in the KXE memory even after the instrument is turned off.

7.0 Data Logging

7.1 Data Logging in Mode “S” Standard

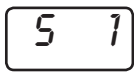
1. Turn on the tension meter and select the “S” Standard Memory Mode as described in Section 6.1.
2. Insert the process material as described in Section 4.1.
3. **To save the first measuring period**, press and hold the **MEM** key until the display shows the memory mode “S” and the current memory number .
4. Release the **MEM** key.

The tension meter starts logging the data.

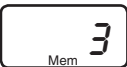
While the tension data are stored, the **MEM** indicator blinks  on the display and the currently measured value is displayed

To stop data logging:

When you want to end the measuring period, press the **MEM** key once again. The statistical values are calculated from the logged tension data and stored in the following order:

- Average value,
- Last value,
- Maximum value (MAX),
- Minimum value (MIN),
- Minimum peak value (MIN PEAK),
- Maximum peak value (MAX PEAK).

The **MEM**  indicator stops blinking and remains on the display. The tension meter shows the current reading and changes back to measuring mode.

To save the next measuring period:

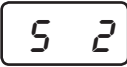
1. Press the **MEM** key again. The display shows the memory mode “**S**” and the next memory number . You can save up to 255 measuring periods.

7.2 Data Logging in Mode “C” Continuous

1. Turn on the tension meter and select the “**C**” Continuous Memory Mode as described in Section 6.1.
2. Insert the process material as described in Section 4.1.
3. **To save the first measuring period**, press and hold the **MEM** key until the display shows the memory mode “**C**” and the current memory number .
4. Release the **MEM** key. The tension meter starts logging the data.

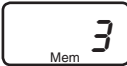
While the tension data are stored, the **MEM** indicator blinks  on the display and the currently measured value is displayed.

8. Press the **RECALL** key. The DISPLAY blinks,  showing the **minimum peak value** (PEAK MIN) of the measuring period, the PEAK indicator and the ∇ symbol.
9. Press the **RECALL** key. The next measuring period (POS: 2) is shown on the DISPLAY, starting at the beginning of the sequence with the **average value** (AVG).

8.2 Recalling the Stored Tension Values in Mode “C” CONTINUOUS

1. Tension meter switched on as described in Chapter 3.2.
2. Press the **RECALL** key.

NOTE: You can end recall any time by pressing the **POWER** key.

| Memory Mode CONTINUOUS | | | | | | | |
|------------------------|------|-----------------------|------|-----------------------|------|-----------------------|------|
| Pos: | 1 | Pos: | 12 | Pos: | 3 | Pos: | 4 |
| AVG: | 22.0 | AVG: | 12.0 | AVG: | 12.0 | AVG: | 12.0 |
| Last: | 23.0 | Last: | 22.1 | Last: | 22.1 | Last: | 22.1 |
| MAX: | 24.0 | MAX: | 22.1 | MAX: | 22.1 | MAX: | 22.1 |
| MIN: | 21.0 | MIN: | 5.4 | MIN: | 5.4 | MIN: | 5.4 |
| PEAK _{MAX} : | 26.0 | PEAK _{MAX} : | 28.1 | PEAK _{MAX} : | 28.1 | PEAK _{MAX} : | 28.1 |
| PEAK _{MIN} : | 19.0 | PEAK _{MIN} : | 1.8 | PEAK _{MIN} : | 1.8 | PEAK _{MIN} : | 1.8 |
| | 10.8 | | 14.2 | | 14.1 | | 15.4 |
| | 10.0 | | 19.4 | | 11.2 | | 18.3 |
| | 7.3 | | 22.9 | | 8.9 | | 17.5 |
| | 6.1 | | 17.3 | | 10.2 | | 7.8 |
| | | | | | | | |
| | n | | n | | n | | n |

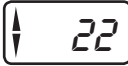
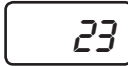
3. The DISPLAY blinks, showing  the **average value** (AVG) of the first measuring period (POS: 1) and the ∇ symbol.
4. Press the **RECALL** key. The DISPLAY blinks, showing  the **last value** (LAST) of the measuring period.

8.0 Recalling the stored tension values







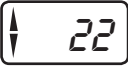

Using the TENSION INSPECT software included with your tension meter, you can easily and accurately evaluate the stored tension values and export them to an Excel sheet.

8.1 Recalling the Stored Tension Values in Mode “S” STANDARD

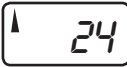
1. Tension meter switched on as described in Chapter 3.2.
2. Press the **RECALL** key.

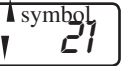
NOTE: You can end recall any time by pressing the **POWER** key.

| Memory Mode STANDARD | | | | | | | |
|-----------------------|------|-----------------------|------|-----------------------|------|-----------------------|------|
| Pos: | 1 | Pos: | 12 | Pos: | 3 | Pos: | 4 |
| AVG: | 22.0 | AVG: | 12.0 | AVG: | 12.0 | AVG: | 12.0 |
| Last: | 23.0 | Last: | 22.1 | Last: | 22.1 | Last: | 22.1 |
| MAX: | 24.0 | MAX: | 22.1 | MAX: | 22.1 | MAX: | 22.1 |
| MIN: | 21.0 | MIN: | 5.4 | MIN: | 5.4 | MIN: | 5.4 |
| PEAK _{MAX} : | 26.0 | PEAK _{MAX} : | 28.1 | PEAK _{MAX} : | 28.1 | PEAK _{MAX} : | 28.1 |
| PEAK _{MIN} : | 19.0 | PEAK _{MIN} : | 1.8 | PEAK _{MIN} : | 1.8 | PEAK _{MIN} : | 1.8 |

3. The DISPLAY blinks, showing  the **average value** (AVG) of the first measuring period (POS: 1) and the  symbol.
4. Press the **RECALL** key. The DISPLAY blinks, showing  the **last value** (LAST) of the measuring period.
5. Press the **RECALL** key. The DISPLAY blinks, showing  the **maximum** value (MAX) of the measuring period and the  symbol.
6. Press the **RECALL** key. The DISPLAY blinks, showing  the **minimum value** (MIN) of the measuring period and the  symbol.
7. Press the **RECALL** key. The DISPLAY blinks, showing  the **maximum peak value** (PEAK MAX) of the measuring period, the PEAK indicator and the  symbol

To stop data logging:

When you want to end the measuring period, press the **MEM** key once again. The statistical values are calculated from the logged tension data and stored in the following order:

Average value,
 Last value,
 Maximum value (MAX),
 Minimum value (MIN),
 Minimum peak value (MIN PEAK),
 Maximum peak value (MAX PEAK),
 Tension Value - 1 -
 Tension Value - 2 -
 ⋮

Tension Value - N - (up to 4000 tension values in up to 255 measuring periods)

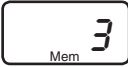
The **MEM**  indicator stops blinking and remains on the display. The tension meter shows the current reading and changes back to measuring mode.

To save the next measuring period:

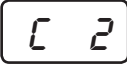
1. Press the **MEM** key again. The display shows the memory mode “**C**” and the next memory number . You can save up to 255 measuring periods with a maximum of 4000 readings.

7.3 Data Logging in Mode “L” Limit

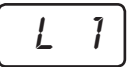
1. Turn on the tension meter and select the “**L**” Limit Memory Mode as described in Section 6.1.
2. Insert the process material as described in Section 4.1.
3. **To save the first measuring period**, press and hold the **MEM** key until the display shows the memory mode “**L**” and the current memory number .
4. Release the **MEM** key. The tension meter starts logging the data.

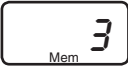
While the tension data are stored, the **MEM** indicator blinks  on the display and the currently measured value is displayed.

To stop data logging:

When you want to end the measuring period, press the **MEM** key once again. The statistical values are calculated from the logged tension data and stored in the following order:

Average value,
Last value,
Maximum value (MAX),
Minimum value (MIN),
Minimum peak value (MIN PEAK),
Maximum peak value (MAX PEAK).
Tension Value - 1 -
Tension Value - 2 -
⋮
Tension Value - 10 - (up to 10 tension values in up to 255 measuring periods)

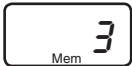
The **MEM**  indicator stops blinking and remains on the display. The tension meter shows the current reading and changes back to measuring mode.

To save the next measuring period:

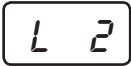
1. Press the **MEM** key again. The display shows the memory mode “**L**” and the next memory number . You can save up to 255 measuring periods with a maximum of 10 readings each.

7.4 Data Logging in Mode “F” Fast

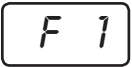
1. Turn on the tension meter and select the “**F**” Fast Memory Mode as described in Section 6.1.
2. Insert the process material as described in Section 4.1.
3. **To save the first measuring period**, press and hold the **MEM** key until the display shows the memory mode “**L**” and the current memory number .
4. Release the **MEM** key. The tension meter starts logging data at the rate of 100 readings per second

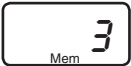
While the tension data are stored, the **MEM** indicator blinks  on the display and the currently measured value is displayed.

To stop data logging:

When you want to end the measuring period, press the **MEM** key once again. The statistical values are calculated from the logged tension data and stored in the following order:

Average value,
Last value,
Maximum value (MAX),
Minimum value (MIN),
Minimum peak value (MIN PEAK),
Maximum peak value (MAX PEAK).
Tension Value - 1 -
Tension Value - 2 -
⋮
Tension Value - N - (up to 4000 tension values in up to 255 measuring periods)

The **MEM**  indicator stops blinking and remains on the display. The tension meter shows the current reading and changes back to measuring mode.

To save the next measuring period:

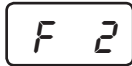
1. Press the **MEM** key again. The display shows the memory mode “**F**” and the next memory number . You can save up to 255 measuring periods with a maximum of 4000 readings.

8.0 Recalling the stored tension values

Using the TENSION INSPECT software included with your tension meter, you can easily and accurately evaluate the stored tension values and export them to an Excel sheet.

8.1 Recalling the Stored Tension Values in Mode “S” STANDARD

1. Tension meter switched on as described in Chapter 3.2.
2. Press the **RECALL** key.

NOTE: You can end recall any time by pressing the **POWER** key.

Warp Tension Meter Model KXE

