

DILLON

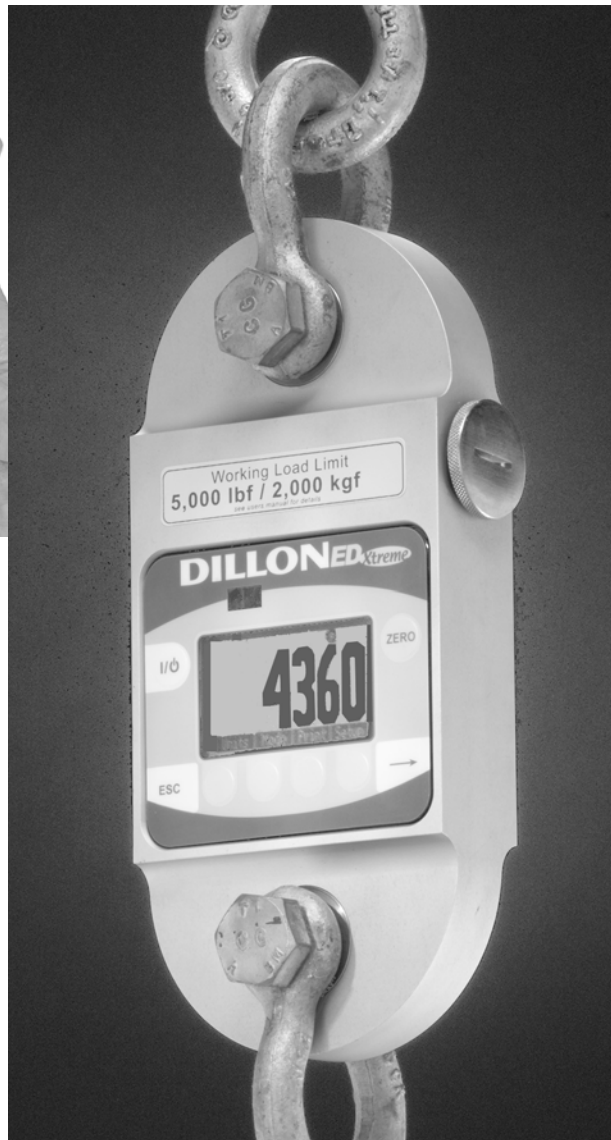

*Optional
Communicator*



EDxtreme Dynamometer and Crane Scale User's Manual

CE



Read and understand this manual before using the equipment. Failure to follow instructions can result in serious injury or death.

IMPORTANT

This equipment must be routinely checked for proper operation and calibration. Application and usage will determine the frequency of calibration required for safe operation.

Table of Contents

Table of Contents	3
Specifications	4
Safe Operation	5
Radio Safety	6
Radio Communications Reliability	6
Introduction	7
EDX & Communicator Description	7
EDX Front Panel	7
EDxtreme Connector	8
Communicator Front Panel	8
Communicator Connectors	9
Power On and Annunciators	10
EDX Setup	11
Setup Menu	11
Configuration	16
Configuration Menu	17
EDX Operation	24
Display Modes	24
Force Measurement	24
Force Measurement Rezero	24
Displaying Peak Force	24
Communicator Operation	26
Powerup Display	26
Setup Menu	27
Config Menu	28
Communicator Print Formats	29
General Information	31
Changing Batteries	31
Battery Life	31
Care	31
Radio Information	31
Installing Spacers	32
Common Configurations and Settings	34
FCC Information	35
Modifications	35
Troubleshooting	36
Weigh and Force Measurement Practice	38
Load Centering	38
Alignment	38
Proper Pin Fit	38
Torque and Bending	38
Certified Gear	38
Good Force Measurement Practice	39

Specifications

Dynamometer Specifications

Enclosure: Designed to NEMA4X/IP55. Suitable for continuous outdoor use.

Accuracy: 0.1% of capacity.*

Repeatability: 0.1% of capacity.*

*1 part in 1000 display mode with Dillon provided shackles.

Factor of safety: 2.5K to 10K = 7:1 USF
25K to 100K = 5:1 USF, 220K to 330K 4:1 USF

Body Protection: Aluminum capacities are anodized. Alloy steel capacities are electroless-nickel plated.

Bearings: Unmatched repeatability attained by needle bearings in shackle pin holes up to EDx-10K. Shackle pin acts as inner race.

Shackles: Forged industry standard anchor shackles. Models up to EDx-10K use precision machined shackle pin. Higher capacities use forged pin.

Display: 128 x 64 dot-graphic LCD display shows up to 6 digits 1.0" (26mm) high plus annunciators and softkeys. Digits are .11 inches (3mm) thick for unmatched readability.

Display update rate: 2 times per second.

Connector: Recessed sealed connector may be used for serial communications or connection to a Communicator remote.

RS-232 / RS-485 communication: Print or extract data easily. Continuous output can drive a scoreboard. Configurable poll character.

Calibration: Traceable to the National Institute of Standards and Technology. Certificate included with curve of readings. Passes only with three consecutive confirming runs, with all points in specification.

Battery life: 320 hours typical use with two C-cell alkaline batteries. 40 hours typical with Radio Link system.

Operating temperature: -4° F to 140° F (-20° to 60° C)

Included with instrument: Carry case, batteries, manual and certificate of calibration. EDx-50K and EDx-100K with shackles include shackle crate and spacers.

Options: Shackles. 2.4 GHz radio board. Display backlight.

Approval: FCC ID: KQL-PKLR2400
CAN ID: CAN2268391158A
CE #: 89/336/EEC, 98/37/EEC, EN61000-4
Registration: 595129
TELEC certification:



AC3124-10-01



003NY0659 0000

Communicator Specifications

Enclosure: Designed to NEMA 3 / IP44 with optional sleeve. Suitable for protected outdoor use.

Instrument size: 9.0 x 4.6 x 1.8 inch (228 x 117 x 45mm).

Accuracy: Not applicable. Only sends and receives digital information.

Display: 128 x 64 dot-graphic LCD display can show full readings up to 5 instruments.

Battery life: 60 hours wireline, 20 hours radio using four AA alkaline batteries under typical use.

Operating temperature: -4° F to 140° F (-20° to 60° C)

Connectors: Sealed connectors may be used for serial communications and wired connection to an EDxtreme dynamometer.

RS-232 communication: Print or extract data easily. Continuous output can drive a scoreboard. Configurable poll character.

Included with remote: Carry case and batteries.

Accessories: Rubberized case protector sleeve. Remote wall mount bracket. Serial and remote cable assemblies.

Radio Specifications

FCC Certified: For unlicensed low power devices. No radio licensing or permits required for normal operation.* (In the US and Canada. Check local ordinances in other countries.)

Frequency: 2.4 GHz spread-spectrum operates between 2.402 – 2.478 GHz. Continuously and automatically changes frequencies many times per second for consistent, reliable communications.

Output Level: 10 mW (20 dBm)

Display Update Rate: 2 times per second with single dynamometer. Multi-instrument networks result in reduced updates.

Number of networks: 63 remotes can operate independently in the same airspace with unique channels.

Number of links remote can control: Up to 15 addresses are available per network channel.

Configuration: Address and Network channels are front-panel configurable.

Antenna: Integral antenna.

Range: Open-air – Up to 300 feet, line-of-sight.
Indoors – Dependent upon installation site with 150 feet common.

Safe Operation



Warning

*If you overload this dynamometer you could suffer severe injuries or death. The total load on the dynamometer should **NEVER** exceed the rated capacity.*



Caution

***CAUTION:** Remove batteries from instrument when using the external AC power supply.*

Keep all the following in mind as you use the EDX dynamometer.

The system capacity is equal to the rating of the dynamometers. The shackle rating should not be used to determine lift capacity of the system.

The shackles are rated in metric tons. Thus the 12-ton shackles are rated to 26,450 lbf and are suitable for use on the 25,000 lbf dynamometer.

Any zeroed deadload must be considered as part of the ultimate load.

Although this instrument has a substantial overload protection rating, the instrument should not be used above the rated capacity. Doing so can significantly impact fatigue life of the instrument and cause premature and abrupt failure. If a higher capacity reading is needed, Dillon insists that a larger instrument be used.

Safety is always a concern in overhead lifting and tensioning applications. To limit your liability always insist upon factory supplied shackles and pins and factory tested and certified safe optional equipment. All DILLON products are designed to meet the published Safe Working Load (SWL) and Ultimate Safety Factor (USF) standards of the United States Military.

Do not grind, stamp, drill or deform the metal on the dynamometer body in any way. Protect the instrument from impact in use and storage.

Any significant damage or deformation to the loading element is cause for evaluation by Dillon, **particularly** in the element side members to the right and left of the display.

Relieve all torsional and off axis loads.

Apply load in the center of the shackle bow with this instrument.

Off center loading results in substandard performance.

Instrument requires time to stabilize when changing temperatures.

Use only the hardware supplied with this instrument. If no hardware was supplied, insure that the mating pin and shackle bow is equivalent to the hardware used at calibration. Otherwise substandard performance or failure can result.

Dillon recommends only using qualified rigging hardware and cannot be responsible for unapproved hardware.

This instrument is not designed for the following:

- Applications that see rapid, dramatic temperature swings or thermal shock. Wide variation in readings can occur.
- Environments with high electromagnetic fields such as cranes employing electromagnets to lift metal. These induce trace voltages that are picked up within the load cell lead wiring and appear as inaccurate loads.
- Intrinsically safe environments. This unit has not been Factory Mutual tested.

Radio Safety

The radiated output power of this device is far below the FCC radio frequency exposure limits. Nevertheless, the device shall be used in such manner that the potential for human contact during normal operation is minimized.

When connecting an external antenna to the device, the antenna shall be placed in such a manner to minimize the potential for human contact during normal operation. In order to avoid the possibility of exceeding the FCC radio frequency exposure limits, human proximity to the antenna shall not be less than 3 inch (7.5 cm) during normal operation. The antenna is located at the connector panel on the Communicator.

Radio Communications Reliability



Low power radio systems should not be used in applications where timely updates of readings are required for safety purposes.

Radio systems are vulnerable to interference, resulting in delays between the dynamometer scale and remote. In some instances of interference, the display shown on the remote may be several seconds old. This can result in a hazardous situation when the system is used as the reference for acceptable loads in cases such as proof loading and monitoring of binding or overload. In these applications where timely updates are critical, a communication cable should be used to physically connect the EDxtreme and Communicator remote (see setup of RS-485 communications). Alternately, the EDxtreme display can be observed directly.

Introduction



Warning

*If you overload this dynamometer you could suffer severe injuries or death. The total load on the dynamometer should **NEVER** exceed the rated capacity.*

The EDxtreme™ (EDX) electronic dynamometer from Dillon is a force measurement load sensor and digital readout in one instrument. The EDX can be used to measure tension or weight. It can operate stand-alone or be coupled with a remote Dillon Communicator, via radio communication or direct wire connection, for improved convenience, functionality and safety.

This manual covers the setup and operation of the EDX and optional Communicator. General information is covered in the right column of each page with major sections separated by the black bar shown above. Sub-heads appear in the left column along with any special notes, cautions or warnings.

This manual covers the following:

- EDX & Communicator Description
- EDX Setup
- Communicator Setup
- EDX & Communicator Operation
- Troubleshooting

Be sure to read the safety precautions found in the *Safe Operation* section.

EDX & Communicator Description

EDX Front Panel

The EDX comes in several weight capacities. All have the same front panel, shown in Figure 1.

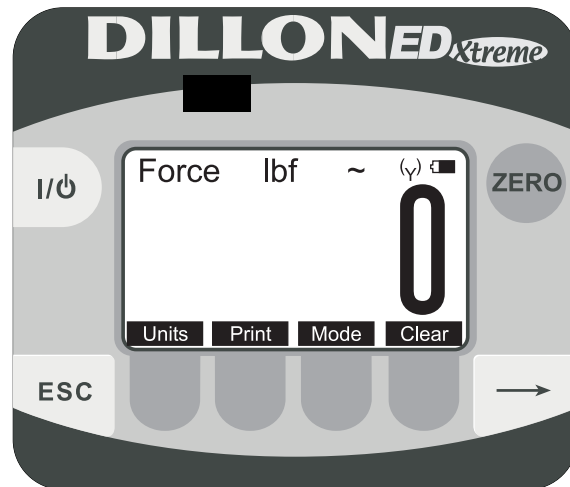

Figure 1
EDxtreme front panel

EDX Keys

There are four “hard” keys and four “soft” keys. The hard keys are permanently labeled and the soft keys are just below the display. The soft key functions change and the key label appears above each key on the display. **Sometimes the individual soft keys are referred to as the F1, F2, F3 and F4 keys as numbered from left to right.**

If you press and hold the **ZERO** key for five seconds, the EDX display will show the zero reference calibration point.

	On/Off key	Use this key to turn the unit on and off.
	ZERO key	Use this key to zero the force indicated on the display.
	ESC key	Use this key to escape from portions of the menu structure and return to previous choices or displays.
	Arrow key	Use this key to access any available soft keys not currently viewed.

EDxtreme Connector

The connector on the EDxtreme is recessed for protection. It is used to connect the instrument to a Communicator remote display/controller, printer or external power supply. See your Dillon distributor for details.

Communicator Front Panel

Figure 2 shows the Dillon Communicator. This is a battery powered, radio-linked (or wired) remote display and control unit.

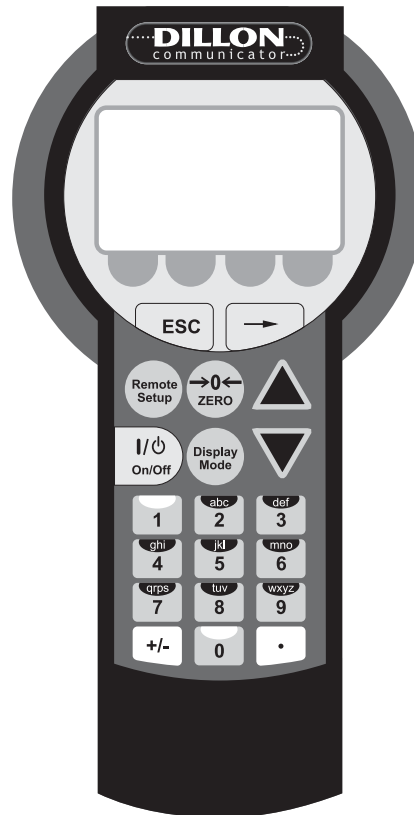

Figure 2
Dillon Communicator

Communicator Keys

*If you press and hold the **ZERO** key for five seconds, the Communicator will reset the active EDX to the zero reference calibration point.*

The Communicator has the same keys as the EDX but also some extra ones. They are all explained below:



On/Off key

Use this key to turn the unit on and off. Also, when in Radio Mode, this key will access a menu for further options.



ZERO key

Use this key to zero the force indicated on the EDX and Communicator displays.



ESC key

Use this key to escape from portions of the menu structure and return to previous choices or displays.



Arrow key

Use this key to access any available soft keys not currently viewed.



Up and Down key

Use these arrow keys to move through menu choices, when applicable. Also scrolls through any active links.



Remote Setup key

Use this key to access the Setup menu.



Display Mode key

Use this key to cycle between Communicator display modes. They are EDX specific force value, EDX specific peak value, multiple display of force values and multiple display of peak values.



Keypad keys

Use these keys to enter numeric characters. Use for address assignments and other miscellaneous data entry.

Communicator Connectors

The Communicator may have between 2-3 connectors. CELL is for wireline communications with an EDxtreme. COM1 is for serial communications. AUX is not presently used and is either nonfunctional or not installed.

Power On and Annunciators

Depending on permission settings and/or revision of firmware, various soft keys may be in a different location or not visible.

lbf and kgf are units of force, not weight. They will be close to their mass counterparts, lb and kg, for most applications and at most locations. See Config>Units for more information.

Arrow key

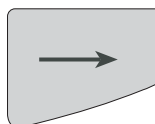

When you power up the EDX you will see a display similar to the example shown on the left in Figure 3.

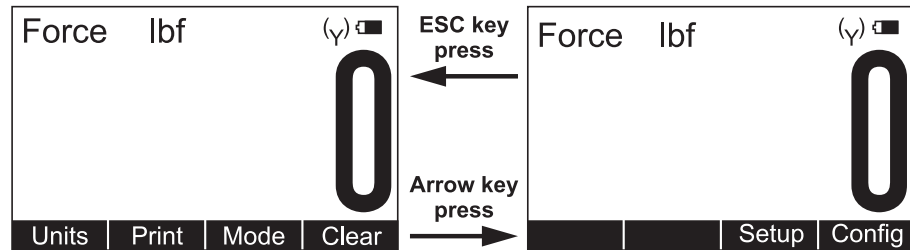

Figure 3
Initial displays

The display sample above shows several symbols you may see on your display but usually not all at the same time.

- Force.** This tells you that the display is showing live force measurement at the moment. Will show **Peak** when viewing Peak Mode.
- lbf** Current unit of measure is lbf in this example. May also be kgf, N, or up to 2 other custom units.
- ~** Motion symbol. This appears when the force is in motion. This symbol disappears when motion ceases.
- Y** This shows the radio is configured ON but is not in communications with any Communicator.
- Y** The battery in the device is low and the radio section has been turned off. The device will continue to display (EDX will display force applied and Communicator will display dashes) but will be unable to communicate by radio or, EDX or the Communicator are improperly configured for RF communications on Comm port #2 with no RF PC board installed.
- (Y) (Y)** 2 Ys indicate the Communicator is in communications with an active EDX.
- Battery annunciator. This shows approximate remaining battery life.
- P** Capture of a new peak value. This annunciator will remain lit for a few seconds.

Press the **Arrow** key to move between the two displays in Figure 3. In the display on the right in Figure 3, one of the soft keys is labeled **Setup**. Press this and you gain access to the soft keys shown in the Setup Menu in Figure 4.

EDX Setup

To begin using the EDX, it is recommended that you set it up to suit your specific needs and equipment. You can access the **SETUP** menu with the softkeys. Refer to page 34 for some common configurations.

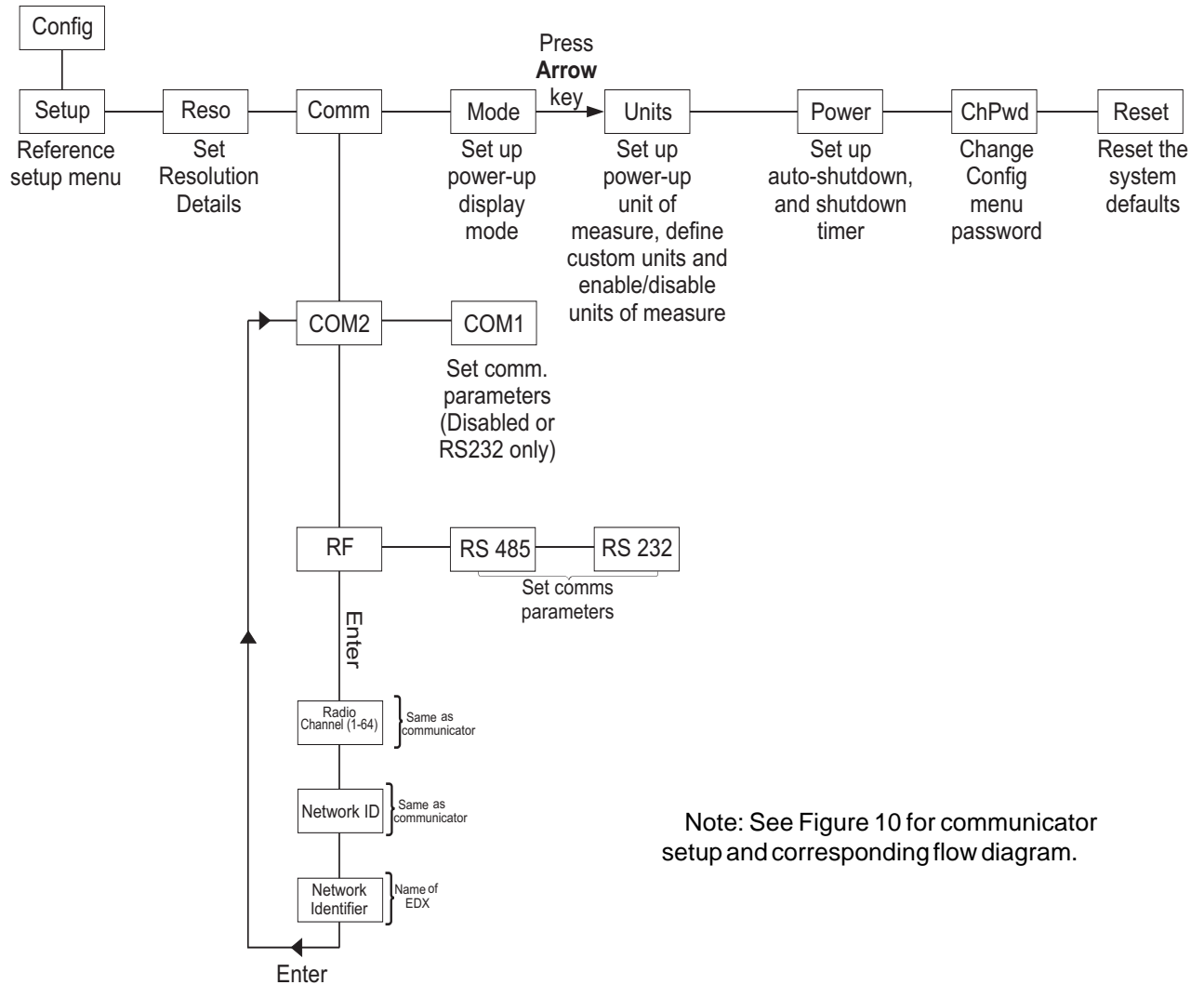

Note: See Figure 10 for communicator setup and corresponding flow diagram.

Figure 4
Operator setup menu for the EDxtreme

Setup Menu

Press the appropriate soft key shown in Figure 4 to accomplish the functions listed on the following pages.

Setup
Ptfmt

Press the **Ptfmt** soft key to select the print format that will be sent to a peripheral printer when you press the **Print** soft key. Choose from the formats below. Data sent is shown below. The default is format #1.

Format #1 Current displayed value (peak or live force) plus unit of measure

104.5 lbf (live force example)
302.5 lbf (peak force example)
104.5 lbf (dual mode example)
302.5 lbf

Format #2 Live force value plus unit of measure on 1st line
Peak force and unit of measure on 2nd line

104.5 lbf
302.5 lbf

Format #3 Live force value plus unit of measure on 1st line
Peak force and unit of measure on 2nd line
Descriptive prefixes on each line

Force 104.5 lbf
Peak 302.5 lbf

Format #4 Fixed position output. Works well with RS-232 utilities, such as WedgeLink, for parsing into a spreadsheet such as Microsoft

Excel. (comma separated)

Excel	A	B
1	104.5	lbf
2	302.5	lbf

Fixed characters.

Position	Description
1-8	Live force number
10-16	Displayed unit of measure (up to 7 characters)
18-25	Peak force number
27-33	Displayed unit of measure (up to 7 characters)
9,17,26	Commas
34	Carriage return

Example 1

<sp><sp><sp>104.5,<sp><sp><sp><sp>lbf, <sp><sp><sp>302.5,<sp><sp><sp><sp>lbf<CR>

Example 2 (custom unit)

<sp>140000.,<sp><sp><sp><sp><sp>kg,<sp>165450.,,<sp><sp><sp><sp><sp>kg<CR>

This would yield (shown in courier):

```

1111111111222222222233333333333444444444455555555
123456789012345678901234567890123456789012345678901234567
104.5,    lbf,    302.5,    lbf, <CR>
140000.,    kg, 165450.,    kg, <CR>

```

Format #5 Live force, unit of measure, peak force, unit of measure. All tab separated.

104.5<tab>lbf<CR> (if presently displaying live readings)

302.5<tab>lbf<CR> (if presently displaying peak readings)

104.5<tab>lbf<tab>302.5<tab>lbf<CR> (if presently displaying dual mode)

Setup Misc

Sometimes the individual soft keys are referred to as the F1, F2, F3 and F4 keys as numbered from left to right.

Use of the backlight will affect battery life.

Setup About

Dillon suggests that calibration data be recorded and saved.

Press the **Misc** key to access the following soft key set (refer to Figure 4):

Flash Press this soft key to enable or disable the “display flash” feedback. If enabled, the press of a key causes the display to momentarily flash to give you a visual feedback that the key was activated.

Zero Press this soft key enable or disable if a press of the **Zero** key also clears the Peak force value. If you enable this function, press the **Zero** key to clear the Peak force and zero the load. If you disable the function, the **Zero** key will only zero the load. Peak force remains in effect and will only be cleared with the Clear function during operation.

Contr Press this key to adjust the contrast of the LCD display. Press the **Up** soft key to lighten the contrast. Press the **Down** soft key to darken the contrast.

There is a keypad shortcut for increasing and decreasing contrast. While in normal display mode press **Arrow** key and **F2** simultaneously to increase contrast. Press **Arrow** key and **F1** simultaneously to decrease contrast.

Blite If the optional backlight is installed, press this key to adjust the backlight brightness and sleep timer functions. Press the **Inten** soft key to set the background brightness. Press the **Mode** soft key to set the backlight configuration options. There is a keypad shortcut for increasing and decreasing backlight intensity.

Press **Arrow** key and **F4** simultaneously to increase intensity. Press **Arrow** key and **F3** simultaneously to decrease intensity.

The next soft key is the **About**. The About menu shows an assortment of information about your Dillon instrument. This can be handy for maintaining calibration, troubleshooting or determining if the firmware can be upgraded. Press this and access the following soft key set (refer to Figure 4):

Device Press this to see software revision and dynamometer information.

Calib This soft key access the following soft key set:

Points Press this key to display the calibration loading points. This is useful information that can be keyed in manually in the event instrument memory is ever accidentally overwritten or corrupted.

Print Press this key to transmit all the calibration information available to a serial printer or computer.

Setup Test

O.Load	Lists the number of overloads that have occurred since the last calibration.
Zero	Lists the current zero point compared to the calibration zero point. If the zero point has moved significantly, this may indicate a serious overload has occurred and the instrument should be returned for service.
Ntwrk	Lists radio information; the enabled channel and identifier.

The Test functions can help service technicians remotely diagnose your Dillon instrument by showing information on key internal functions. Typically these menus will have significance only to trained technicians. You may look at these menus without technical guidance, but the information may have little meaning, or an error may be reported that may not exist.

Press this key to access several items described below (refer to Figure 4):

Batt	Press this key to perform a battery test. This shows the battery level in A-D counts and approximate voltage. Voltage is not calibrated.
A-D	Press this key to test the A-D section of the EDX. You need to apply force to change the counts and test the unit. The A-D is the electronics portion that converts analog load cell signal to digital numbers.
Disp.	Press this key to perform a display test. Stop the test by pressing the ESC key.
Keys	Press this key to perform key tests. Any key pressed will be reflected in the display. Press ESC to end the test.
Ntwrk	Press this key to perform a self-test of the radio's system.
Comm	The serial test is an internally conducted diagnostic which requires a jumper across transmit and receive. This requires a plug or cable assembly. Pressing the Serial soft key accesses the following soft keys: COM1 Press this key to test COM1 in a loopback test. COM2 Press this key to test COM2 in a loopback test.

To perform a COMM test, the unit must be configured to use RS-232 communications.

The configuration menu is a group of settings that may be password protected if desired to prevent operators from making significant system changes. It is used to configure the following:

- radio network
- resolution
- communication ports
- power up display mode
- units of measure
- power management
- password management
- system default reset

To access the configuration menu, press the **Config** soft key shown in Figure 5.

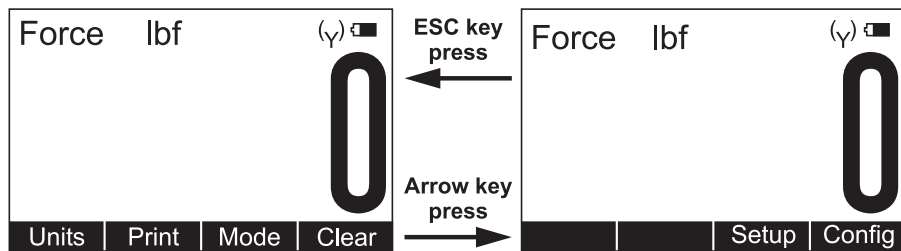

Figure 5
Accessing Config soft key and menu

The display prompts for a password. See Figure 6.

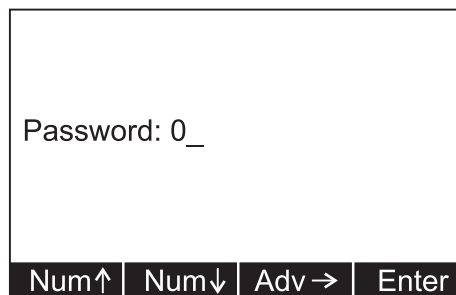

Figure 6
Password screen

The default password is "0". If the password has been changed and forgotten, contact your Dillon distributor for assistance.

Use the **Num** keys to enter the first character of the password and the **Adv** key to move to the next character. When you are done press the **Enter** key and the soft keys shown in Figure 7 become available.

Configuration Menu

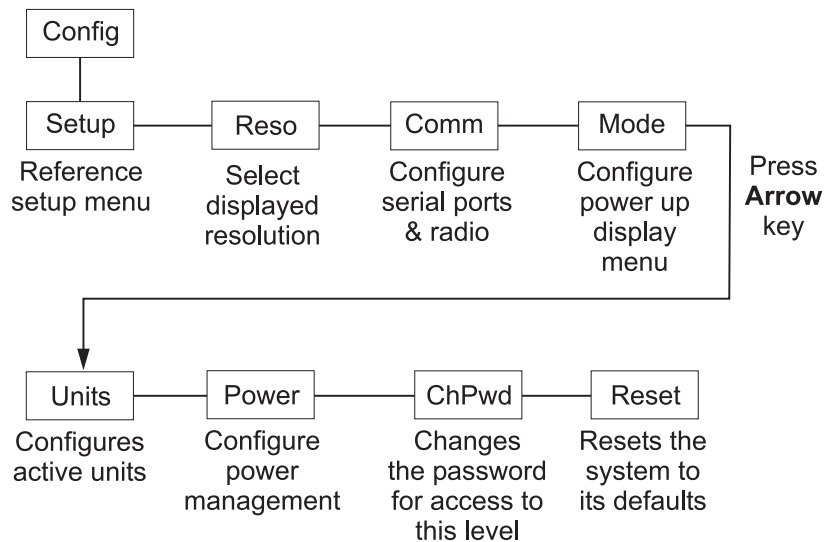

Figure 7
Configuration menu

Config Setup

The first soft key is **Setup**. Press this and you access the setup menu shown in Figure 4. All its features are covered in that section of the manual.

Config Reso

Enhanced Resolution mode drains more battery power than standard resolution.

Reso stands for resolution. Resolution is the value by which the EDX displays increments. Press this key to set the unit to standard (1000 divisions) resolution or enhanced (5000 divisions) resolution. For example: 10,000 lbf would count by

10 lbf (10,000 lbf/1000 divisions = 10 lbf) in standard resolution

2 lbf (10,000 lbf/5000 divisions = 2 lbf) in enhanced resolution

Standard resolution may have 1000 or 1250 divisions. Enhanced resolution may have 4000 or 5000 divisions. This follows normal display increment practice of changing by 1, 2, 5 or a multiple or submultiple of those numbers (e.g. 10, 20, 50, .1, .2, .5, etc.)

Config Comm

RS-232/RS-485 activity consumes more battery power.

COM2 is used to configure the optional radio board, if installed.

*If you set the Trans Level to RF, steps 3-5 are automatically set and **do not** appear.*

*The * indicates which option is currently selected.*

The second serial port requires a larger connector. The standard 4-pin connector only has one serial connection (COM 2).

Press this key to enable or disable radio communication and configure serial ports.

To configure serial ports, follow these steps:

1. Press the **Comm** key and you see the following screen:

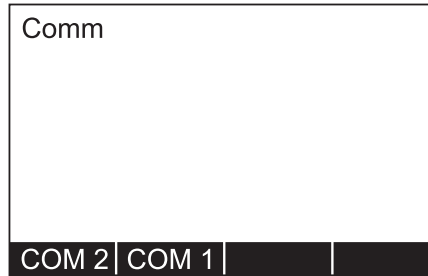

2. Press **COM 2** or **COM 1**.

The following display appears.

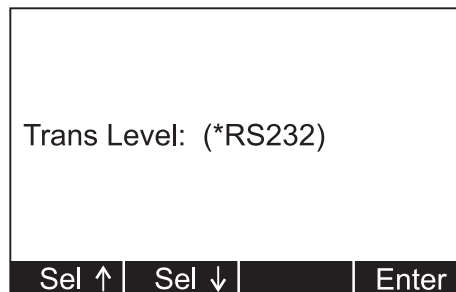

3. Select a transmission level using the **Sel** keys to scroll through the four choices; Disabled (default), RS232, RS485, and RF. RF stands for Radio Frequency and means transmission would be by radio (requires optional radio board). Press **Enter** to accept the setting. See note at left.

The following display appears:

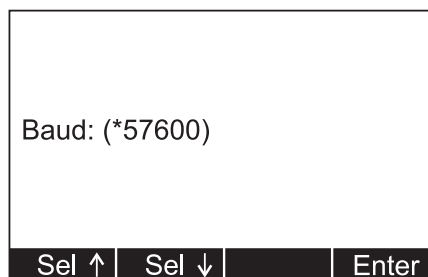

Default Serial Communications

Baud Rate = 57600
Parity = None
Databits = 8
Stop bits = 1

There is no option for handshakes. All settings should be None.

4. Select a baud rate using the **Sel** keys to scroll through your choices. Choices are 1200, 2400, 4800, 9600, 19200, 38400, 57600 (default), and 115200. Press **Enter** to accept the setting.

The following display appears:

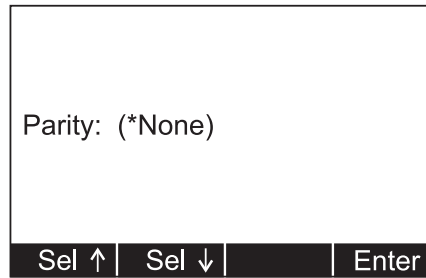

5. Select a parity value using the **Sel** keys to scroll through your choices. Choices are none (default), odd and even. Press **Enter** to accept the setting.

The following display appears:

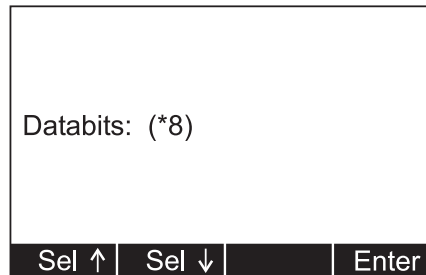

6. Select a databit value using the **Sel** keys to toggle between the two choices; 7 or 8 (default). Press **Enter** to accept the setting.

The following display appears.

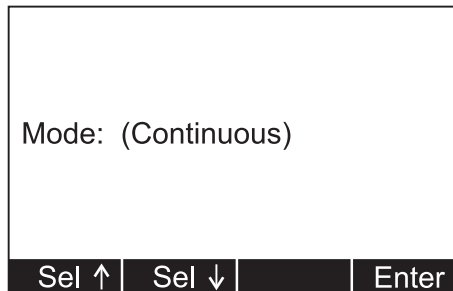

7. Select a mode of communication you want using the **Sel** keys to scroll through these choices; Continuous, Poll, Remote and Print Key Only. Press **Enter** to accept the setting.

If you choose Continuous, you will be prompted to select a print format for the transmission and a rate at which you want to send the transmission.

If you choose Poll you will be prompted to enter a poll character.

Choose Remote for wireline communications.

Choose Print Key Only to print only when the **Print** key is pressed.

8. Repeat steps 2-7 for the other serial port if it needs configuring.
9. Press **ESC** to return to the first soft key set of the Configuration menu.

Config Mode

If you enable the radio:

You are asked to enter a Radio Channel. Your EDX and Communicator must be on the same channel to function together. Key in a number from 1 through 64. 1 is the default setting. Press **Enter** to accept.

You are asked to enter a Network ID#. This is a unique address number (1-15) so the Communicator only speaks to one instrument at a time without "cross-talking." Use the available soft keys to enter a number (1-15), then press **Enter** to accept.

You are then asked to key in an alternate network identifier. Use the available soft keys to enter alpha characters, then press **Enter** to accept.

The next menu key is the **Mode** key. Use this key to choose what display mode is active upon powerup.

1. Press the **Mode** key.

The following is displayed:

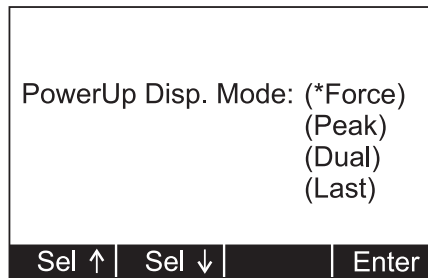

See the *Display Modes* section under *EDX Operation* for more detail on display modes.

Asterisk shows current selection. *(Last)* causes display to power up in same mode as when last powered down.

2. Select a display mode value using the **Sel** key to scroll through the choices. Press **Enter** to accept the displayed setting.

The display returns to the first soft key set of the Configuration menu.

Config Units

The next soft key is **Units**. Use this item to set the units of measure you want available when you use the **Units** key in the normal operating mode. This can also assign custom units.

Custom units are typically used for any of three purposes:

1. To display a unit of measure not found in the standard options, such as ton, tonne, dyne, or KIP.
2. To apply a multiplier when multipart line systems or other static line arrangements are used. For example, if a 4-part line is used, the dynamometer at the dead end can display approximate total weight by using a multiplier of 4.

It is critical that the operator understands the relationship between the dynamometer and custom unit. For example, assume a custom unit of kg is entered where $1 \text{ kg} = 5 \text{ kgf}$ (as seen at the dynamometer). The operator could become confused, think that a 1000 kg display means that there is still 4000 kg of capacity remaining.

3. To compensate for local gravitational differences. There are variances in gravity throughout the world. If used as a scale, variances due to gravitational differences can be handled by having the instrument calibrated on-site with certified dead weights or by using the custom units. Simply divide the gravitational constant at your location by 9.80665 m/s^2 (or 32.1741 ft/s^2) and use this as the multiplier entry. A less accurate alternative : If the constant is not known, lift a weight of known mass close to the capacity of the instrument. In enhanced resolution mode, observe the reading. Divide the actual by the observed reading and use this as the multiplier entry.

Config Power

Powering the instrument off regularly allows the batteries to partially recover and maximizes energy extractions from the batteries.

Key presses reset the timer. Characters received through the serial port also reset the timer.

The next soft key is the **Power** key. Use this to set power management features.

1. Press the **Power** key.

The following is displayed:

Enable Auto-Shutdown? (Yes)			
No	Yes		Enter

Auto-Shutdown powers off the instrument automatically. The instrument can be programmed for a fixed operating time or programmed to shut down after a period of inactivity.

Standby Timer(min): 10_			
Num↑	Num↓	Adv→	Enter

Timer reflects the period required to pass before Auto-Shutdown activates.

The following screen is displayed:

Motion Resets Timer? (Yes)			
No	Yes		Enter

Select **Yes** if you only want the instrument to automatically shut down when there is inactivity. Select **No** if you want the instrument to power down after the timer counts down, regardless of any activity.

Config
ChPwd

The next soft key is **ChPwd**. Use this to change the password used to access the configuration menu. **IMPORTANT: Changing the password denies access to this menu without entry of the new password. Contact your Dillon distributor if you lose your password.**

Config
Reset

The last soft key in this set is the **Reset** soft key. Use this to reset the system to its factory default settings.

This concludes the Configuration menu section.

EDX Operation

Display Modes

Power up display modes may be configured. See Config>Mode section.

The EDX has several display modes accessible by pressing the **Mode** soft key. See Figure 8.

The first display mode when you power up is the live force measurement mode.

Press the **Mode** soft key and the display changes to peak measurement mode. This mode shows the peak force applied to the EDX since the last peak clearing action. Delete the peak reading by pressing the **Clear** soft key.

Press the **Mode** soft key again and the display shows live force and peak readings simultaneously.

Press the **Mode** soft key again and the display returns to the force measurement mode.

Force Measurement

Unit of measure can be changed only if multiple units are enabled in the Configuration menu.

Follow these steps to perform a gross force measurement.

1. Turn on the unit with the **On/Off** key.
2. Remove any weight from the EDX.
3. Zero the EDX by pressing the **ZERO** key.
4. Apply the force to the EDX and read the gross force on the display.

You can change the units of measure of the display by pressing the **Units** soft key. See note at left. Zero reference is maintained after instrument power off and will be recalled with the next power-on. Zero reference may be lost if battery power is removed.

Force Measurement Rezero

Rezeroing allows the weight or load of fixturing to be invisible to the measurement. **The zeroed load must always be considered as part of the maximum capacity.**

1. Turn on the unit with the **On/Off** key.
2. Remove any weight from the EDX.
3. Zero the EDX by pressing the **ZERO** key.
4. Apply the tare force to the EDX and press the **ZERO** key.
5. Apply the force to the EDX and read the net force on the display.

Steps 2 and 3 are not required if the weight of the fixturing is not needed. This should be maintained, however, to know cumulative loads.

Displaying Peak Force

The EDX will store the peak force applied until that reading is cleared. To display the peak force applied to an EDX, from the force measurement mode, press the **Mode** soft key. The display changes to display menu #2 shown in Figure 8 which is the peak display mode. The peak force is displayed. You can clear this by pressing the **Clear** soft key.

Peak reading is maintained after instrument power off and will be recalled with the next power-on. Peak reading may be lost if battery power is removed.

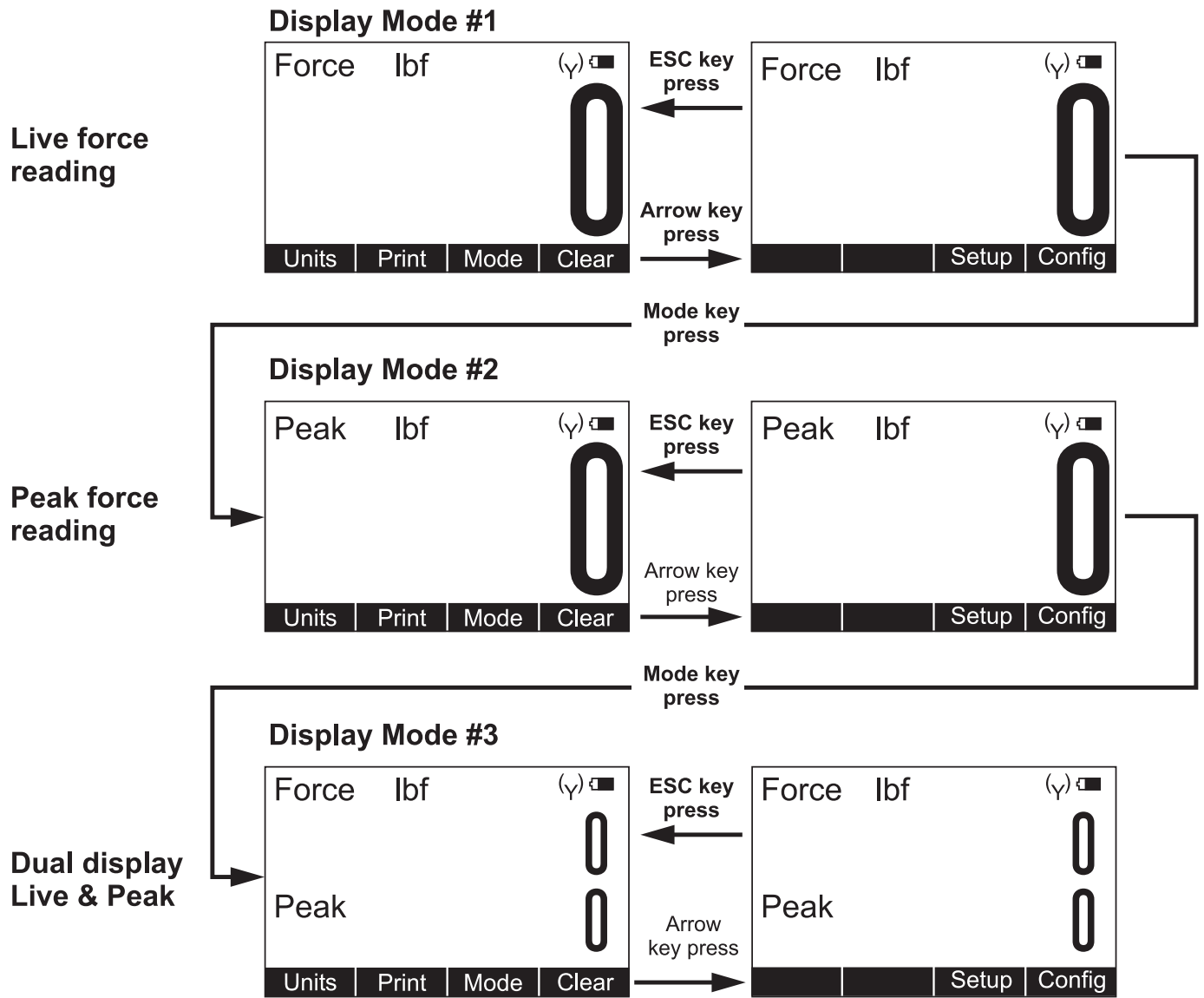

Figure 8
Display mode menu

Press the **Mode** soft key repeatedly until the desired display mode is reached.

Communicator Operation



Use the **UP** and **DOWN** arrow keys on the Communicator to scroll through the displays of all active EDXs and a total screen.

The Dillon Communicator is a remote display and control module designed to work with the EDxtreme. It can be connected by wire or can communicate by radio if both the Communicator and EDxtreme are equipped with optional radio boards.

The Communicator may simultaneously view and control several dynamometers at one time. Each is monitored individually by assigning unique numeric identifiers to each (addresses).

Several Communicators may operate in the same airspace if they are on different channels.

For best performance always have different identifiers for EDxtremes within the same network and use different channels for systems operating anywhere close to one another.

Since most functions are identical, you should refer to the EDxtreme section for comprehensive explanation and the Communicator's section will highlight differences that exist.

The Communicator is designed to be similar in layout and function to an EDxtreme to make operation easy and intuitive. The main screen appears as it does on the EDxtreme except that the Mode soft key has been blanked. This has an actual hard key on the remote.

Powerup Display



These annunciators on the Communicator display show battery level and radio operation for the Communicator (right side pair) and the active EDxtreme (left side pair).

An example of a Communicator's powerup display is shown below:

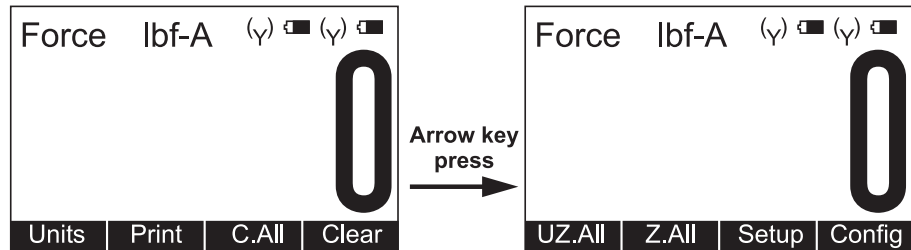

There are three soft keys on the first display and 4 on the second display. The soft key functions are described below:

- Units** Changes the displayed unit of measure. Each press advances the display through this sequence; lbf, kgf, N, custom 1, custom 2.
- Print** Outputs serial data to peripheral devices attached to COM 1.
- C.All** Clears the peaks on all EDXs currently in communication with the remote.
- Clear** Clears the current peak value of the active EDX.
- UZ.All** Resets all EDXs to calibration zero reference point.
- Z.All** Zeros all EDXs currently in communication with the remote.
- Setup** Accesses the Setup menu shown in Figure 9.
- Config** Accesses the Config menu shown in Figure 10.

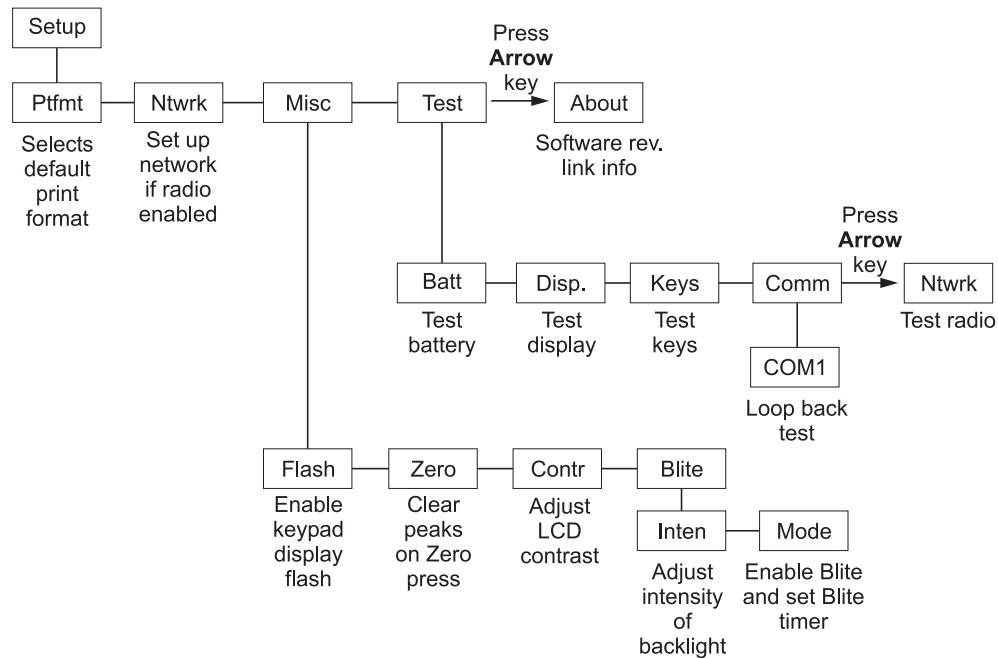

Figure 9
Setup menu

Setup Menu

Contrast shortcut

There is a keypad shortcut for increasing and decreasing contrast. While in normal display mode press **Arrow** key and **F2** simultaneously to increase contrast. Press **Arrow** key and **F1** simultaneously to decrease contrast.

Backlight intensity shortcut

Press **Arrow** key and **F4** simultaneously to increase intensity. Press **Arrow** key and **F3** simultaneously to decrease intensity.

Ptfmt	Select from print formats 1-7. See <i>Print Formats</i> section on the following pages.
Ntwrk	Setup the network. First choice is Radio Channel #. Can pick 1-64. All EDXs set to this same number will communicate with this Communicator. Next choice is number of EDXs in the network. Pick from 1-15 Next choice, you must set the address for each EDX. Each EDX in the network must have a unique number. Pick from 1-15.
Misc	Lets you setup the following items: Flash Use this to enable the visual confirmation of keystrokes. Display will flash on keystrokes if enabled. Zero Use this to enable or disable clearing of peak force values upon ZERO key press or Z.All soft key press. Contr Use this to adjust the contrast of the Communicator display. Follow onscreen prompts for directions. Blite Use this to adjust the intensity and mode of the optional backlight. Intensity adjusts the brightness of the backlight. Using Mode you can set the backlight to OFF, ON, or TIMER. If you select TIMER, the backlight will shut off after a configurable period of time (in seconds), without a keystroke. You are also given the option of choosing if motion will reset the backlight timer to start counting again.
Test	Lets you test the following items: Batt Press this to check the battery condition. Display shows voltage condition of the batteries. Disp Press this to perform a display test. Press any key to stop the test.

Keys Press this key to test individual key function. Press **ESC** to stop the test.

Comm Press this key to perform LOOP/NOLOOP tests on COM1. Press **ESC** to return to **Test** soft key display. COM1 must be enabled in Config menu to test.

Ntwrk Press this key to perform a radio test.

About Press this soft key to see the following information:

- Communicator Serial Number
- Firmware part number
- Revision level of software

Press **ESC** repeatedly to return to normal operation. If you have made changes you will be prompted to save the changes. Press the **Save** soft key to save the changes and return to normal operation. Press the **noSave** soft key to disregard any changes made and return to normal operation. Press the **Cancel** soft key to return to the Setup menu screen.

This completes the Setup menu description.

Config Menu

The configuration menu, shown in Figure 10, allows you to set the items described below. Press the **Config** soft key to enter the menu. You will be asked to key in a password, then press the **Enter** soft key to access the menu.

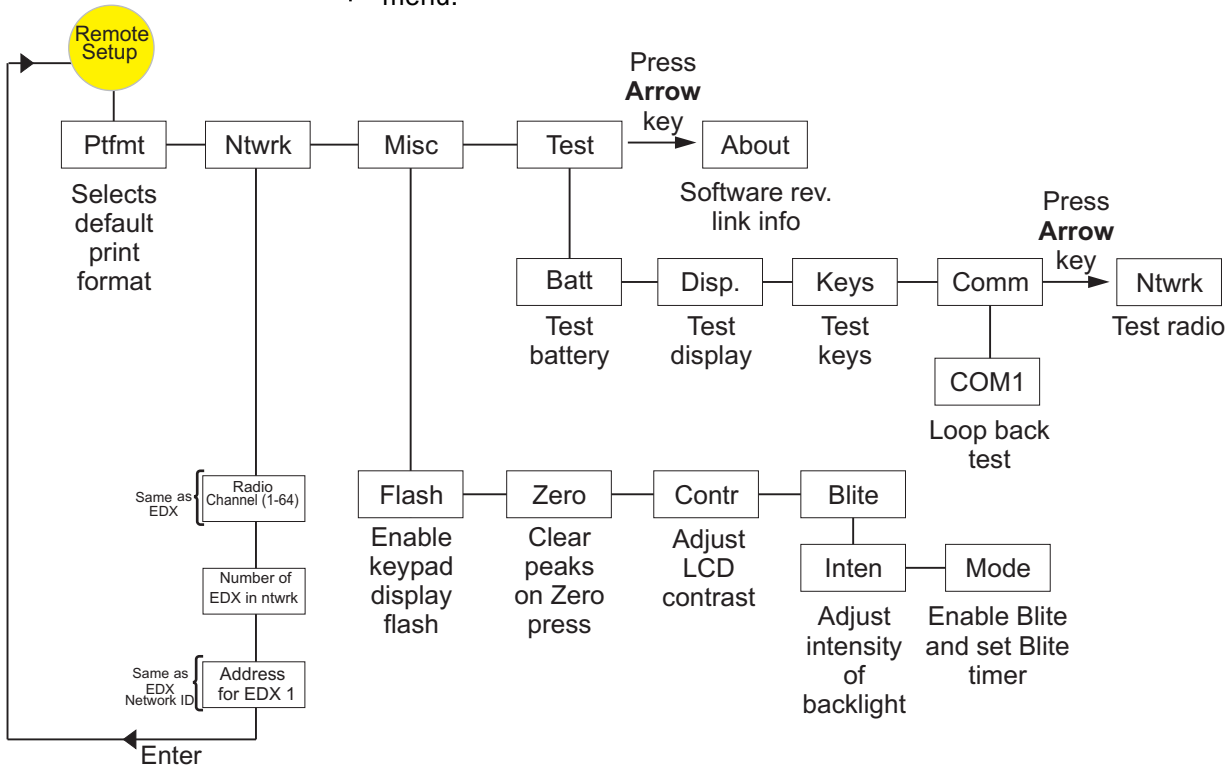

Figure 10
Config(uration) menu

- Mode** Press this to set the display mode that will be active upon power-up.
- Units** Press this key to set the following:
Choice of power-up unit of measure
Enable or disable lbf, kgf, N, custom unit 1 and 2
- Power** Press this to set the following:
Enable Auto-shutdown (Y/N)
Shutdown Timer (set minutes before idleness causes unit to shut off)
- Chpwd** Press this to change the Config menu password.
- Reset** Press and you are given the choice of resetting the Communicator to its factory defaults.

Communicator Print Formats

Press the **Ptfmt** soft key to select the print format that will be sent from the Communicator on Com 1 to a peripheral printer when you press the **Print** soft key. Choose from the formats below. Data sent is shown below. The default is format #1.

Format #1 Current displayed value (peak or live force) plus unit of measure on the active EDX only.

104.5 lbf (live force example)
302.5 lbf (peak force example)

Format #2 Live force value plus unit of measure on 1st line and Peak force and unit of measure on 2nd line for active EDX only.

104.5 lbf
302.5 lbf

Format #3 Live force value plus unit of measure on 1st line and Peak force and unit of measure on 2nd line with descriptive prefixes on each line for active EDX only.

Force 104.5 lbf
Peak 302.5 lbf

Format #4 Fixed position output for active EDX only. Works well with RS-232 utilities, such as WedgeLink, for parsing into a spreadsheet such as Microsoft Excel.

Excel	A	B
1	104.5	lbf
2	302.5	lbf

Fixed characters.

Position	Description
1-8	Live force number
10-16	Displayed unit of measure (up to 7 characters)
18-25	Peak force number
27-33	Displayed unit of measure (up to 7 characters)
9,17,26	Commas
34	Carriage Return

Example 1

<sp><sp><sp>104.5,<sp><sp><sp><sp>lbf,<sp><sp><sp>302.5,<sp><sp><sp><sp>lbf<CR>

Example 2 (custom unit)

<sp>140000.,<sp><sp><sp><sp><sp>kg,<sp>165450.,,<sp><sp><sp><sp><sp>kg<CR>

This would yield (shown in courier):

11111111111222222222233333333333444444444455555555
123456789012345678901234567890123456789012345678901234567

104.5, lbf, 302.5, lbf<CR>

140000., kg, 165450., kg<CR>

Format #5 Live force, unit of measure, peak force, unit of measure for active EDxtreme only. All tab separated.

104.5<tab>lbf<CR> (if presently displaying live readings)

302.5<tab>lbf<CR> (if presently displaying peak readings)

Format #6 Cell #, description, live force, unit of measure for all active EDXs plus a total.

Example:

Cell<tab>Description<tab>Live Force<tab>Units<CR>

1<tab>North<tab>104.5<tab>lbf<CR>

2<tab>South<tab>4801<tab>lbf<CR>

Total<tab><tab>4905.5<tab>lbf

Format #7 Outputs print format #6 plus peak values for all EDXs.

General Information

Changing Batteries

To replace discharged batteries, unscrew the battery compartment cap on the right side of the dynamometer. Remove the two C cells and replace them with the + poles inserted first. If the spring in the cap becomes detached, you can reattach it by aligning the large end over the counterbored hole and turning the spring counterclockwise while pushing the spring into the hole. The spring will work into the recess and be self-retained.

The Communicator has 4 AA batteries. To replace, remove rear battery cover and replace with fresh batteries in the proper arrangement.

Battery Life



Caution

CAUTION: Remove batteries from instrument when using the external AC power supply.

The time required between battery changes can vary with usage, functions enabled, temperature, duration of use and recovery time, display update rate, battery grade and more.

To maximize battery life:

- Disable radio if not being used. Even if an optional radio board is not installed, the software will run, if enabled.
- Disable other functions such as RS-232 and backlight.
- Warm environments result in longer battery life over cool environments.
- Use high quality alkaline batteries.
- Turn off instrument when not in use. Alkaline batteries partially recover when the instrument is off.

Care

The EDxtreme is built to be rugged and endure typical industrial and commercial use. It is still, however, a precision instrument that should be treated with care. Store the instrument in its carry case with power off. Remove batteries if not being used.

Radio Information

The radio technology used in the radio equipped EDxtreme and Communicator is a 2.4 GHz digital spread spectrum system designed for communications reliability. Radio operation and the performance attained can be difficult to predict and will vary with environment and conditions. There are locations where radio use is impractical or even impossible.

Tips for best performance:

- Keep the Communicator and EDxtreme as close as possible together.
- Keep metal and other dense objects as far from the instruments as possible.
- Normally the higher that both the EDxtreme and Communicator are above the ground, the better the performance and range will be.

Many things can degrade radio signals, such as brick walls, metal reinforced concrete, machinery and even wiring within walls. Other systems such as wireless networks and cordless phones may degrade or interfere with operation of the Dillon radio-equipped system. As an FCC approved instrument on a license-free radio band, the instrument must accept interference received from other devices that share the same frequency and airspace. If other systems are colliding, it is best to isolate the device(s) that cause the interference and then take steps to eliminate the problem which may include relocation, conditional operation or retirement of the interfering device.

Installing Spacers

High capacity dynamometers with shackles of 50,000 lbf/20000kgf capacity and up, use spacers, Figure 11, to insure proper centering of the dynamometer for performance and safety reasons.



Figure 11
Spacer

Do not use the dynamometer with shackles if the spacers are not installed. The EDX design incorporates an innovative method to retain these spacers, if desired, to ease shackle installation.

Place spacer on a solid surface and use a hammer to start the roll pins into the two small spacer holes. See Figure 12.



Figure 12
Inserting roll pin

Insert through matching holes in dynamometer body. Lay the dynamometer on the spacers on a solid surface with the roll pins protruding from the top. See Figure 13.

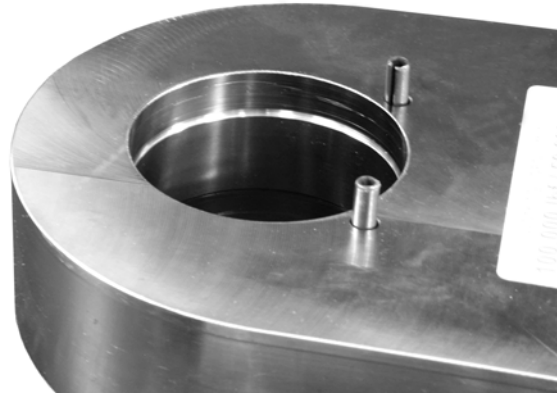

Figure 13
Roll pins extending above dynamometer body

Position the holes of the second spacer over the holes and tap spacer into position. See Figure 14.



Figure 14
Placing second spacer on roll pins

A punch sized slightly smaller than the holes in the spacer may be helpful. The spacers should “sandwich” the dynamometer body, but should not be drawn completely tight.

Remove the four large circular foam plugs from the carry case and it can continue to be used with the spacers attached.

Common Configurations

EDxtreme being used stand-alone (no RS-232 or Communicator remote)

Key Settings (EDxtreme):

COM1 Trans Level – Disabled
COM2 Trans Level – Disabled

EDxtreme connected to a computer

Key Settings (EDxtreme):

COM1 Trans Level – Disabled
COM2 Trans Level – RS-232 (all other parameters should agree with peripheral such as baud, data bits & parity)

Communicator connected to one EDxtreme by wire on CELL port

Key Settings (EDxtreme and Communicator):

COM1 Trans Level – Disabled
COM2 Trans Level – RS-485
Address: 1
Channel: 1

Communicator talking to one EDxtreme by radio

Key Settings (Communicator):

COM1 Trans Level – Disabled or RS-232
COM2 Trans Level – RF
Radio Channel (1-64): 1 (this must differ from all other Communicators in the area)
Number of EDxtremes in the Network (1-15): 1
Address of Edxtreme 1: 1

Key Settings (EDxtreme):

COM1 Trans Level – Disabled
COM2 Trans Level – RF
Radio Channel (1-64): 1 (must match Communicator channel setting)
Network ID (1-15): 1
Network Identifier: (enter characters or digits to identify this specific EDx) (most useful if multiple EDxs are networked to one Communicator)

Communicator talking to four EDxtremes by radio

Key Settings **Communicator**

COM1 Trans Level – Disabled or RS-232
COM2 Trans Level – RF
Radio Channel (1-64): 1 (this must differ from all other Communicators in the area)
Number of EDxtremes in the Network (1-15): 4
Addresss for Edxtreme 1: 1
Addresss for Edxtreme 2: 2
Addresss for Edxtreme 3: 3
Addresss for Edxtreme 4: 4

Key Settings (**EDxtreme 1**):
 COM1 Trans Level – Disabled
 COM2 Trans Level – RF
 Radio Channel (1-64): 1 (must match Communicator channel setting)
 Network ID (1-15): 1
 Network Identifier: A

Key Settings (**EDxtreme 2**):
 COM1 Trans Level – Disabled
 COM2 Trans Level – RF
 Radio Channel (1-64): 1 (must match Communicator channel setting)
 Network ID (1-15): 2
 Network Identifier: B

Key Settings (**EDxtreme 3**):
 COM1 Trans Level – Disabled
 COM2 Trans Level – RF
 Radio Channel (1-64):1 (must match Communicator channel setting)
 Network ID: 3
 Network Identifier : C

Key Settings (**EDxtreme 4**):
 COM1 Trans Level – Disabled
 COM2 Trans Level – RF
 Radio Channel (1-64):1 (must match Communicator channel setting)
 Network ID: 4
 Network Identifier : D

FCC Information



This device complies with Part 15 of the FCC Rules. Operation is subject to the following two conditions:

1. This device may not cause harmful interference, and
2. This device must accept any interference received, including interference that may cause undesired operation.

Agency Identification Numbers	
US/FCC	CAN/IC
KQL-PKLR2400	CAN2268391158A

Modifications

The FCC states that any changes or modifications to this device that are not expressly approved by Dillon may void the user's authority to operate the equipment

Troubleshooting

Problem	Possible Cause	Solution
EDX powers on momentarily and turns off	Low battery	Replace with high quality alkaline batteries
EDX does not power on	Low battery	Replace with high quality alkaline batteries
	Batteries installed backwards or no spring contact	Insure that positive terminals of both batteries (nub) face inward – towards the black cap. Check that spring is attached to the battery cap.
	Software reset	Remove battery cap & reinstall after one minute. Attempt to turn power on again.
	Display contrast too light	Hold the Right Arrow key down while pressing the F2 key several times to increase the display contrast. If nothing occurs, release both keys. Press the power button and try again.
Display is completely dark	Display contrast too dark	Hold the Arrow key down while pressing the F1 key several times to decrease the display contrast.
EDxtreme does not appear accurate	Check installation & system	Insure that shackles are in good working condition and aligned straight. Verify system is applying force directly through the dynamometer with no off center or torsional loads being applied to the instrument.
	Local gravitational variances	If being compared against dead-weights, check your local gravitational constant. Use custom units to compensate or calibrate on-site.
	Check repeatability	Place EDX in low-resolution mode. Lift an arbitrary weight several times as close to capacity as possible. Record each weight reading. Do the readings differ from each other? Calculate the standard deviation of the readings using a spreadsheet such as Microsoft Excel. See if the deviation is greater than 0.1% of the instrument capacity.
	Compare against a reference load.	Place EDX in low-resolution mode. Apply a known load near instrument capacity. Check calibration date.
Radio communication intermittent	Low batteries. Distance is excessive or dead-radio pocket	Bring remote closer to dynamometer. Allow several seconds to retrain.
	Excessive radio noise or interference in environment	Remove dynamometer and remote from the environment. Attempt communications in an area free of local radio signals.
Radio communications not working at all	Dead batteries. Distance is excessive, dead radio pocket	Bring remote closer to dynamometer. Allow several seconds to retrain.
	Radio systems not initialized. No “Y” appears.	Enable the radio system in the COM2 configuration of both instruments (under Comm menu).
	Y Displayed	Change batteries in the device when the Y is blinking.

Problem	Possible Cause	Solution
Radio communications not working at all (continued)	Operating channels matched	Remote and link must be on the same operating channel. See EDxtreme and Communicator configurations of COM2 for radio (under Comm menu).
	Excessive radio noise or interference in environment	Remove dynamometer and remote from the environment. Attempt communications in an area free of local radio signals. See <i>Radio Information</i> section of the manual.
Remote reading changes to dashes	Low batteries, lost communications	See steps above for improving communications.
Display locks up on DILLON marquee	Poor connection between EDX and Communicator	Remove batteries from EDX and Communicator, replace them and power up.

Weighing and Force Measurement Practice

Load Centering

The basis for all electronic force measurement or weighing is measurement of stress in a loadcell body. To obtain optimal results it is necessary to establish a few basic rules, otherwise the effect may be a nonlinear or non-repeatable response. Read and follow these tips and see the illustrations on the next page.

For accurate performance the force acting on the unit must be in line with the unit. Centering the load is accomplished by using the shims on each side of the load cell so that it is centered on the shackle pin. See the illustration at right. The 50,000 lbf (20000 kgf) and higher EDxtremes also include spacers supplied with shackles.

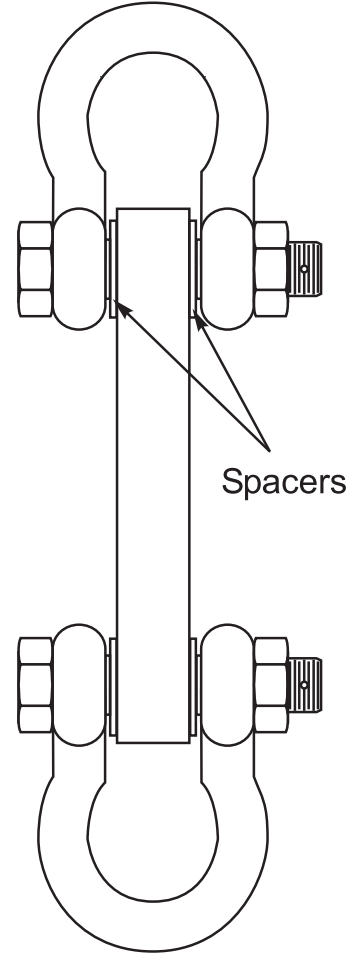

Alignment

Insure shackles are oriented parallel with the instrument. Apply load in the center of the shackle bow.

Proper Pin Fit

A proper fitting pin is important in order to generate an even stress distribution and avoid yield stresses. To achieve published accuracy you must use the shackle pins and centering spacers provided by Dillon.

Torque and Bending

Torque and bending should be avoided. Use swivels on the lifting wire for anti-torque and avoid side forces.

Certified Gear

Certified shackles and lifting gear should always be used in accordance to local laws and federal legislation. Insure all hardware, fittings and line used to sustain the load are properly sized and rated for the installation. Have the system evaluated by a qualified engineer if any question or uncertainty exists.



Albuquerque Industrial
69-10 108th Street # 2-O
Forest Hills, NY 11375 U.S.A.

www.abqindustrial.net
e-mail: info@abqindustrial.net
Toll Free: +1 (888) 275-5772
Tel: +1 (718) 846-6458
Fax: +1 (718) 846-6459

Good Force Measurement Practice

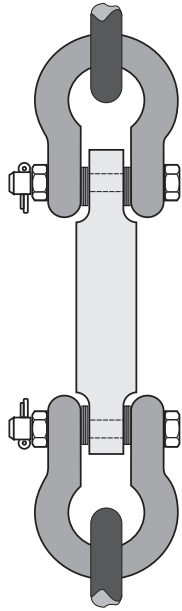

Be sure fixturing does not bind between the body of the EDX and the shackle!

Center the load on the shackle pin. Use spacers where applicable.

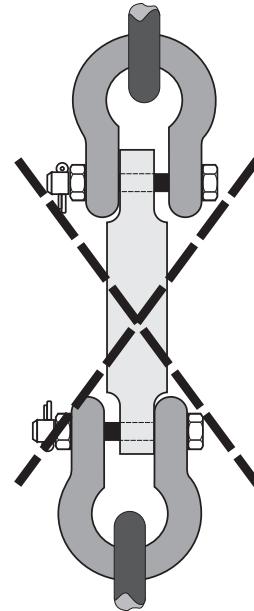

Use only with a pin of the same diameter and hardness as the original factory equipment.

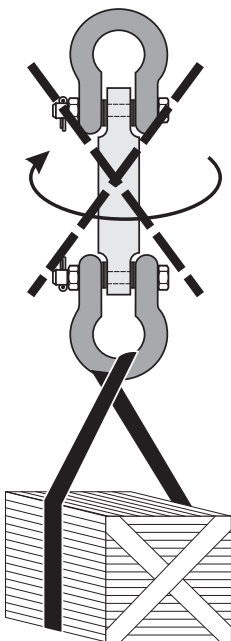
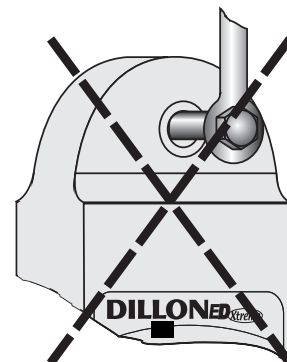

Do not torque, bend or side-load.

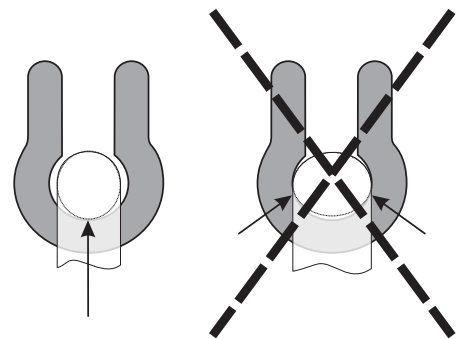
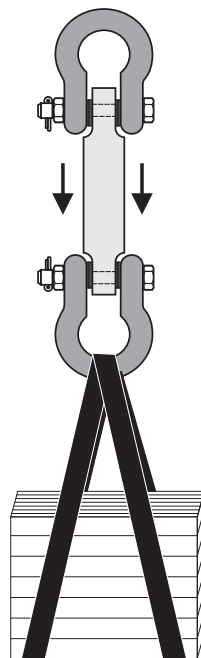

Use hardware that allows single point attachment and freedom of alignment. Do not use hardware that is undersize or restricts self-alignment. This results in poor measurement performance and possible dangerous safety conditions.